



# VENTO Expert A50-1 S10 Pro

Heat recovery single-room units

- Air flow in heat recovery mode: 25
- Sound pressure level LpA at 3 m: 21
- Sound pressure level LpA at 1 m: 30
- Filter: G3 (Option: F7 PM2.5 > 99 %)
- Sound insulation
- Motor type: EC
- Enthalpy heat exchanger
- Control: Remote Control
- Humidity sensor: Built-in
- Shutters

	Unit of measurement	VENTO Expert A50-1 S10 Pro		
Connected air duct size	mm	160		
Speed	-	3		
Minimum supply voltage	V	100		
Maximum supply voltage	V	240		
Power supply frequency	Hz	50/60		
Rated power	W	3.61	4.15	5.2
Unit current	A	0.025	0.03	0.039
Air flow in ventilation mode	m <sup>3</sup> /h	15	30	50
Air flow in heat recovery mode	m <sup>3</sup> /h	8	15	25
rotation speed at 50hz	-	800	1300	1900
Sound pressure level LpA at 3 m	dB(A)	11	18	21
Sound pressure level LpA at 1 m	dB(A)	20	27	30
Heat recovery efficiency, max	%	93		
Heat exchanger material	-	Ceramic		
Filter	-	G3 (Option: F7 PM2.5 > 99 %)		
Transported air temperature (max)	°C	40		
Transported air temperature (min)	°C	-20		
Ambient air temperature min	°C	1		
Ambient air temperature max	°C	40		
Ambient air humidity max	%	80		

Ingress protection rating	-	IP24
---------------------------	---	------

## Dimensions

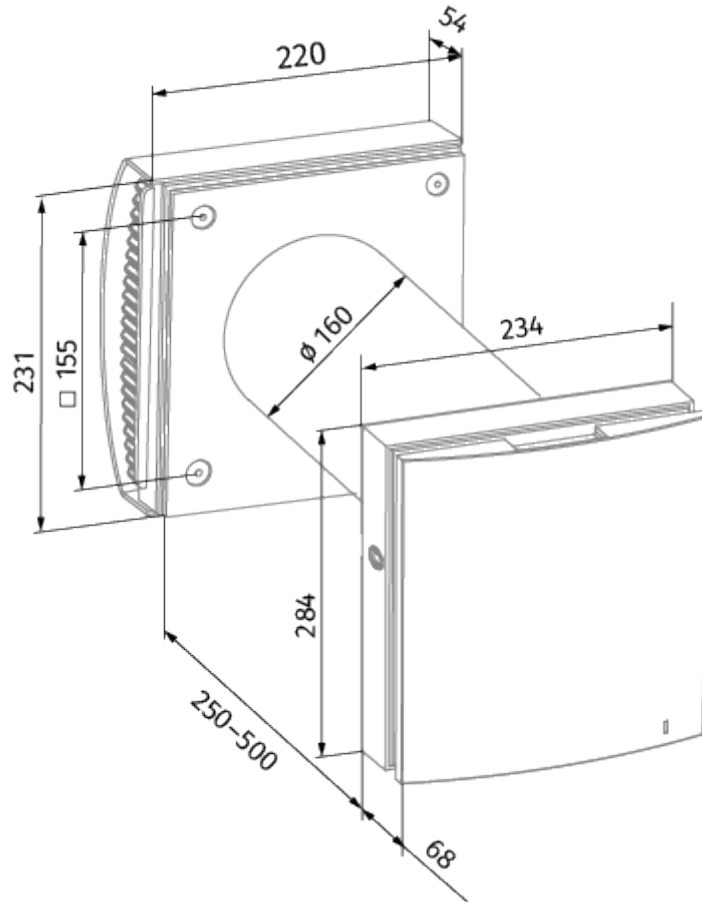



## Ecodesign







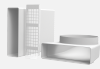







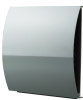

Trademark	Blauberg					
Model	VENTO Expert A50-1 S10 Pro					
Specific energy consumption (SEC) (kWh/(m <sup>2</sup> /a))	Cold		Average		Warm	
	-80.6	A+	-38.8	A	-14.8	E
Type of ventilation unit	Bidirectional					
Type of drive installed	3-speed					
Type of heat recovery system	Regenerative					
Thermal efficiency of heat recovery (%)	77					
Maximum flow rate (m <sup>3</sup> /h)	25					
Electric power input (W)	5.2					
Reference flow rate (m <sup>3</sup> /s)	0.004					
Specific power input (SPI) (W/(m <sup>3</sup> /h))	0.277					
Control typology	Local demand control					
Maximum internal leakage rates (%)	2.7					
Mixing rate (%)	1					
Airflow sensitivity at +20 Pa and -20 Pa (%)	0.2					
The indoor/outdoor air tightness (m <sup>3</sup> /h)	5.2					
Sound power level (dB(A))	38					
Declared typology	RVU BVU					
The annual electricity consumption (AEC) (kWh/a)	Cold		Average		Warm	
	200		200		200	

## Accessories

### Other accessories

Name	Photo	Description
ZL1 Vento 160/150		
KIT BlauPlast white 160		Kit for angular mounting (for walls with standard thickness)
KIT BlauPlast chrome 160		Kit for angular mounting (for walls with standard thickness)

### Hoods



Name	Photo	Description
<a href="#">AH-8 white 160</a>		Outer ventilation hood with frost protection for a cold climate
<a href="#">AH-8 chrome 160</a>		Outer ventilation hood with frost protection for a cold climate
<a href="#">AH-10 beige 160</a>		Plastic hoods decoration of supply and exhaust vents of public, residential and industrial ventilation systems
<a href="#">AH-10 black 160</a>		Plastic hoods decoration of supply and exhaust vents of public, residential and industrial ventilation systems
<a href="#">AH-10 brown 160</a>		Plastic hoods decoration of supply and exhaust vents of public, residential and industrial ventilation systems
<a href="#">AH-10 chrome 160</a>		Plastic hoods decoration of supply and exhaust vents of public, residential and industrial ventilation systems
<a href="#">AH-10 grey 160</a>		Plastic hoods decoration of supply and exhaust vents of public, residential and industrial ventilation systems
<a href="#">AH-10 terracotta 160</a>		Plastic hoods decoration of supply and exhaust vents of public, residential and industrial ventilation systems
<a href="#">AH-10 white 160</a>		Plastic hoods decoration of supply and exhaust vents of public, residential and industrial ventilation systems
<a href="#">AH-11 vintage 160</a>		Plastic hoods decoration of supply and exhaust vents of public, residential and industrial ventilation systems
<a href="#">AH-11 black 160</a>		Plastic hoods decoration of supply and exhaust vents of public, residential and industrial ventilation systems
<a href="#">AH-11 brown 160</a>		Plastic hoods decoration of supply and exhaust vents of public, residential and industrial ventilation systems
<a href="#">AH-11 grey 160</a>		Plastic hoods decoration of supply and exhaust vents of public, residential and industrial ventilation systems
<a href="#">AH-11 terracotta 160</a>		Plastic hoods decoration of supply and exhaust vents of public, residential and industrial ventilation systems

<a href="#">AH-11 white 160</a>		Plastic hoods decoration of supply and exhaust vents of public, residential and industrial ventilation systems
AH-S chrome 160		Stainless steel ventilation hood
AH-S white 160		Stainless steel ventilation hood
<a href="#">PP 160/0.5</a>		The outer hood is designed to prevent the ingress of water and large objects into the ventilation equipment from outside

### Other accessories

Name	Photo	Description
<a href="#">FB Vento Expert A50</a>		Remote control

### CO2 sensors

Name	Photo	Description
<a href="#">CD-1</a>		CO2 sensors
<a href="#">CD-2</a>		CO2 sensors