



VENTO Expert A50-1 S W V.2

Single-room heat recovery units with Wi-Fi control

- Air flow in heat recovery mode: 25
- Sound pressure level LpA at 3 m: 21
- Sound pressure level LpA at 1 m: 30
- Filter: G3 (option: pollen filter)
- Sound insulation
- Motor type: EC
- Enthalpy heat exchanger
- Control: Smartphone
- Humidity sensor: Built-in
- Shutters

	Unit of measurement	VENTO Expert A50-1 S W V.2		
Connected air duct size	mm	160		
Speed	-	3		
Minimum supply voltage	V	100		
Maximum supply voltage	V	240		
Power supply frequency	Hz	50/60		
Rated power	W	4.45	5.08	7.06
Unit current	A	0.035	0.04	0.059
Air flow in ventilation mode	m ³ /h	15	30	50
Air flow in heat recovery mode	m ³ /h	8	15	25
rotation speed at 50hz	-	800	1300	1900
Sound pressure level LpA at 3 m	dB(A)	11	18	21
Sound pressure level LpA at 1 m	dB(A)	20	27	30
Heat recovery efficiency, max	%	93		
Heat exchanger material	-	Ceramic		
Filter	-	G3 (option: pollen filter)		
Transported air temperature (max)	°C	40		
Transported air temperature (min)	°C	-20		
Ambient air temperature min	°C	1		
Ambient air temperature max	°C	40		
Ambient air humidity max	%	80		

Ingress protection rating	-	IP24
---------------------------	---	------

Dimensions

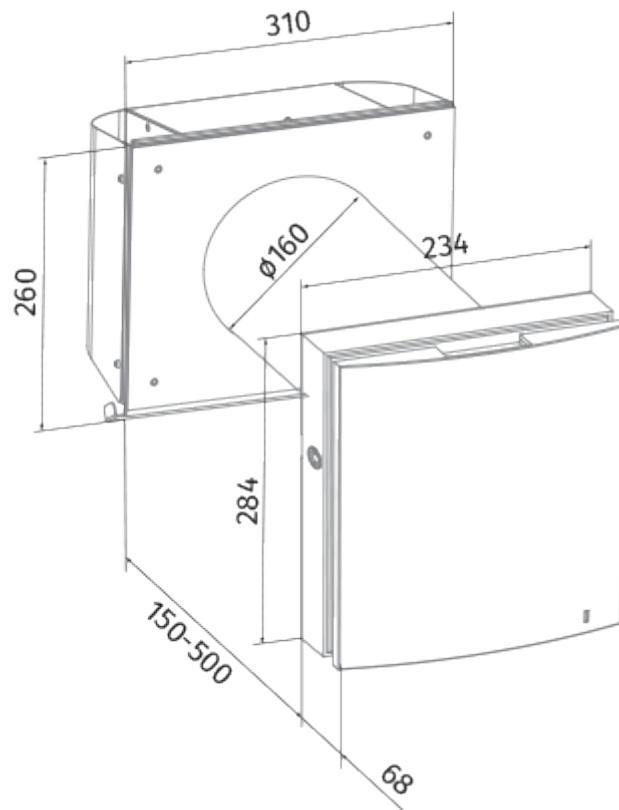



Ecodesign



Trademark	Blauberg					
Model	VENTO Expert A50-1 S W V.2					
Specific energy consumption (SEC) (kWh/(m ² /a))	Cold		Average		Warm	
	-80.7	A+	-38.8	A	-14.9	E
Type of ventilation unit	Bidirectional					
Type of drive installed	Variable speed					
Type of heat recovery system	Regenerative					
Thermal efficiency of heat recovery (%)	77					
Maximum flow rate (m ³ /h)	25					
Electric power input (W)	7.1					
Reference flow rate (m ³ /s)	0.004					
Specific power input (SPI) (W/(m ³ /h))	0.339					
Control typology	Local demand control					
Maximum internal leakage rates (%)	2.7					
Mixing rate (%)	1					
Airflow sensitivity at +20 Pa and -20 Pa (%)	0.2					
The indoor/outdoor air tightness (m ³ /h)	5.2					
Sound power level (dB(A))	38					
Declared typology	RVU BVU					
The annual electricity consumption (AEC) (kWh/a)	Cold		Average		Warm	
	197		197		197	









Accessories







Other accessories

Name	Photo	Description
ZL1 Vento 160/150		
AH-S chrome 160		Stainless steel ventilation hood
AH-S white 160		Stainless steel ventilation hood

KIT BlauPlast white 160		Kit for angular mounting (for walls with standard thickness)
KIT BlauPlast chrome 160		Kit for angular mounting (for walls with standard thickness)
R 160-500		Air duct 160 mm and polystyrene foam plug
R 160-700		Air duct 160 mm and polystyrene foam plug

Hoods

Name	Photo	Description
AH-8 white 160		Outer ventilation hood with frost protection for a cold climate
AH-8 chrome 160		Outer ventilation hood with frost protection for a cold climate
AH-10 beige 160		Plastic hoods decoration of supply and exhaust vents of public, residential and industrial ventilation systems
AH-10 black 160		Plastic hoods decoration of supply and exhaust vents of public, residential and industrial ventilation systems
AH-10 brown 160		Plastic hoods decoration of supply and exhaust vents of public, residential and industrial ventilation systems
AH-10 chrome 160		Plastic hoods decoration of supply and exhaust vents of public, residential and industrial ventilation systems
AH-10 grey 160		Plastic hoods decoration of supply and exhaust vents of public, residential and industrial ventilation systems
AH-10 terracotta 160		Plastic hoods decoration of supply and exhaust vents of public, residential and industrial ventilation systems
AH-10 white 160		Plastic hoods decoration of supply and exhaust vents of public, residential and industrial ventilation systems

AH-11 vintage 160		Plastic hoods decoration of supply and exhaust vents of public, residential and industrial ventilation systems
AH-11 black 160		Plastic hoods decoration of supply and exhaust vents of public, residential and industrial ventilation systems
AH-11 brown 160		Plastic hoods decoration of supply and exhaust vents of public, residential and industrial ventilation systems
AH-11 grey 160		Plastic hoods decoration of supply and exhaust vents of public, residential and industrial ventilation systems
AH-11 terracotta 160		Plastic hoods decoration of supply and exhaust vents of public, residential and industrial ventilation systems
AH-11 white 160		Plastic hoods decoration of supply and exhaust vents of public, residential and industrial ventilation systems
PP 160/0.5		The outer hood is designed to prevent the ingress of water and large objects into the ventilation equipment from outside



Other accessories

Name	Photo	Description
SE Vento Expert W		Control panel

Other accessories

Name	Photo	Description
FB Vento Expert A50		Remote control

Other accessories

Name	Photo	Description
CD-1		CO2 sensors
CD-2		CO2 sensors