



# VENTO Expert A100-1 S10 W V.2 BLK

Single-room heat recovery units with Wi-Fi control

- Air flow in heat recovery mode: 54
- Sound pressure level LpA at 3 m: 42
- Sound pressure level LpA at 1 m: 51
- Heat exchanger type: Reversible
- Filter: G3 (опціонально: F7 PM2,5 > 99 %)
- Sound insulation
- Motor type: EC
- Enthalpy heat exchanger
- Control: Smartphone
- Humidity sensor: Built-in
- CO2 sensor: Optional
- VOC sensor: Optional
- PM2.5 sensor: Optional
- Temperature sensor: Optional
- Shutters

	Unit of measurement	VENTO Expert A100-1 S10 W V.2 BLK			
Connected air duct size	mm	160			
Speed	-	4			
Phases	-	1			
Minimum supply voltage	V	100			
Maximum supply voltage	V	240			
Power supply frequency	Hz	50/60			
Rated power	W	3.20	4.00	6.60	18.00
Unit current	A	0.037	0.046	0.071	0.151
Air flow in ventilation mode	m <sup>3</sup> /h	18	30	58	108
Air flow in heat recovery mode	m <sup>3</sup> /h	9	15	29	54
rotation speed at 50hz	-	780	1100	1920	2940
Sound pressure level LpA at 3 m	dB(A)	13	18	30	42
Sound pressure level LpA at 1 m	dB(A)	23	27	40	51
Heat recovery efficiency, max	%	87			
Heat exchanger type	-	Reversible			
Heat exchanger material	-	Ceramic			
Filter	-	G3 (опціонально: F7 PM2,5 > 99 %)			
Transported air temperature (max)	°C	40			
Transported air temperature (min)	°C	-20			



Ambient air temperature min	°C	1
Ambient air temperature max	°C	40
Ambient air humidity max	%	80
Ingress protection rating	-	IP24

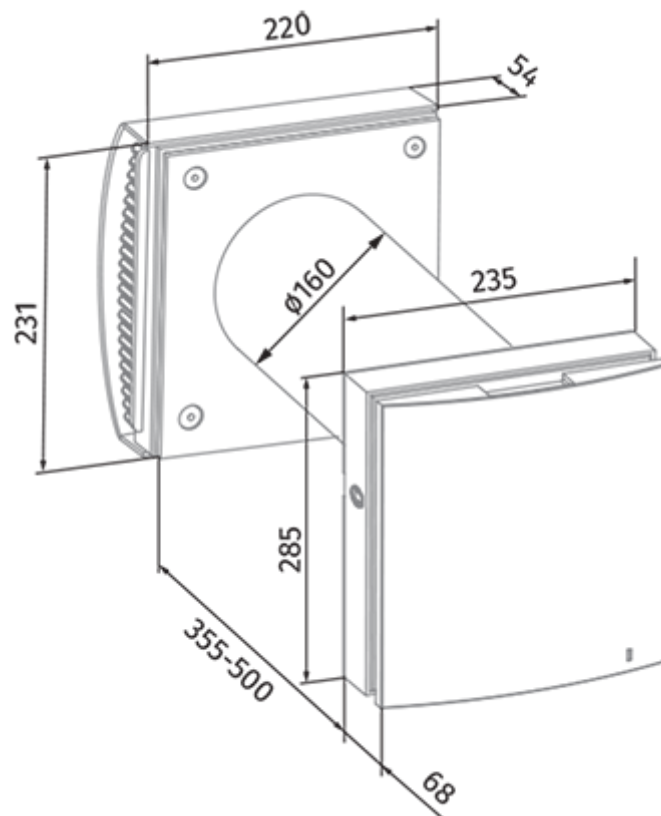









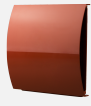

## Dimensions



## Accessories



### Hoods

Name	Photo	Description
<a href="#">AH-10 beige 160</a>		Plastic hoods decoration of supply and exhaust vents of public, residential and industrial ventilation systems
<a href="#">AH-10 black 160</a>		Plastic hoods decoration of supply and exhaust vents of public, residential and industrial ventilation systems
<a href="#">AH-10 brown 160</a>		Plastic hoods decoration of supply and exhaust vents of public, residential and industrial ventilation systems

<a href="#">AH-10 chrome 160</a>		Plastic hoods decoration of supply and exhaust vents of public, residential and industrial ventilation systems
<a href="#">AH-10 grey 160</a>		Plastic hoods decoration of supply and exhaust vents of public, residential and industrial ventilation systems
<a href="#">AH-10 terracotta 160</a>		Plastic hoods decoration of supply and exhaust vents of public, residential and industrial ventilation systems
<a href="#">AH-10 white 160</a>		Plastic hoods decoration of supply and exhaust vents of public, residential and industrial ventilation systems
<a href="#">AH-11 vintage 160</a>		Plastic hoods decoration of supply and exhaust vents of public, residential and industrial ventilation systems
<a href="#">AH-11 black 160</a>		Plastic hoods decoration of supply and exhaust vents of public, residential and industrial ventilation systems
<a href="#">AH-11 brown 160</a>		Plastic hoods decoration of supply and exhaust vents of public, residential and industrial ventilation systems
<a href="#">AH-11 grey 160</a>		Plastic hoods decoration of supply and exhaust vents of public, residential and industrial ventilation systems
<a href="#">AH-11 terracotta 160</a>		Plastic hoods decoration of supply and exhaust vents of public, residential and industrial ventilation systems
<a href="#">AH-11 white 160</a>		Plastic hoods decoration of supply and exhaust vents of public, residential and industrial ventilation systems
AH-S chrome 160		Stainless steel ventilation hood
<a href="#">PP.160/0.5</a>		The outer hood is designed to prevent the ingress of water and large objects into the ventilation equipment from outside

### Other accessories

Name	Photo	Description
KIT BlauPlast white 160		Kit for angular mounting (for walls with standard thickness)

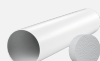
KIT BlauPlast chrome 160		Kit for angular mounting (for walls with standard thickness)
R 160-500		Air duct 160 mm and polystyrene foam plug
R 160-700		Air duct 160 mm and polystyrene foam plug



### Other accessories

Name	Photo	Description
<a href="#">SE Vento Expert W</a>		Control panel

### Other accessories

Name	Photo	Description
<a href="#">FB Vento Expert A50</a>		Remote control

### Other accessories

Name	Photo	Description
<a href="#">CD-1</a>		CO2 sensors
<a href="#">CD-2</a>		CO2 sensors