



Vento Eco Standard S Pro

Heat recovery single-room units. Maximum air flow up to 50 m³/h

- Air flow in heat recovery mode: 25
- Sound pressure level LpA at 3 m: 20
- Sound pressure level LpA at 1 m: 29
- Heat exchanger type: Regenerative
- Filter: G3 (Option: F8 PM2.5 > 99 %)
- Motor type: EC
- Control: Wired control panel
- Casing material: Plastic



	Unit of measurement	Vento Eco Standard S Pro		
Speed	-	3		
Minimum supply voltage	V	100		
Maximum supply voltage	V	240		
Power supply frequency	Hz	50/60		
Rated power	W	1.00	2.10	4.30
Unit current	A	0.017	0.025	0.041
Air flow in ventilation mode	m ³ /h	15	30	50
Air flow in heat recovery mode	m ³ /h	8	15	25
rotation speed at 50hz	-	915	1555	2330
Sound pressure level LpA at 3 m	dB(A)	12	18	20
Sound pressure level LpA at 1 m	dB(A)	21	27	29
Heat recovery efficiency, max	%	92		
Heat exchanger type	-	Regenerative		
Heat exchanger material	-	Ceramic		
Filter	-	G3 (Option: F8 PM2.5 > 99 %)		
Transported air temperature (max)	°C	40		
Transported air temperature (min)	°C	-20		
Ingress protection rating	-	IP24		

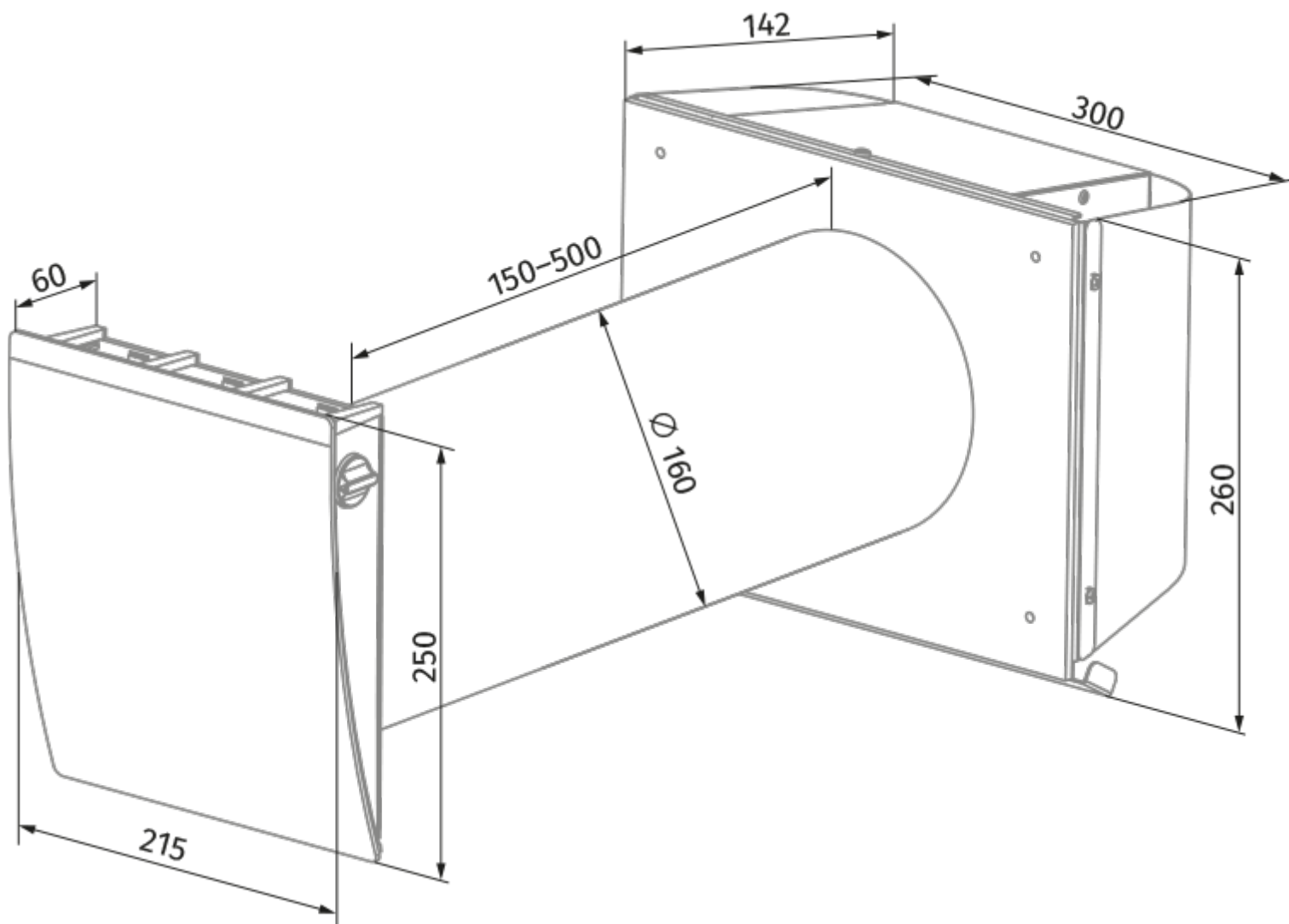



Dimensions







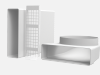

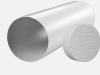
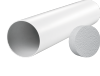
Accessories





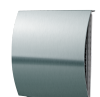
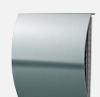





Other accessories

Name	Photo	Description
FP2 Vento G3		G3 filter kit (2 pcs.)
FP2 Vento G4		Coarse filter G4 Contents: • plastic filter holder (1 pc.) • G4 filter (1 pc.)
FP2 Vento F7		Fine filter F7 Includes: • plastic filter holder (1 pc.) • F7 fine filter (1 pc.). Filtration rate PM2.5 > 70 %

FPC 150x50 G4		Filter
FPC 150x50 F7		Filter
KIT BlauPlast white 160		Kit for angular mounting (for walls with standard thickness)
KIT BlauPlast chrome 160		Kit for angular mounting (for walls with standard thickness)
R 160-500		Air duct 160 mm and polystyrene foam plug
R 160-700		Air duct 160 mm and polystyrene foam plug

Hoods

Name	Photo	Description
AH-8 white 160		Outer ventilation hood with frost protection for a cold climate
AH-8 chrome 160		Outer ventilation hood with frost protection for a cold climate
AH-10 chrome 160		Plastic hoods decoration of supply and exhaust vents of public, residential and industrial ventilation systems
AH-10 beige 160		Plastic hoods decoration of supply and exhaust vents of public, residential and industrial ventilation systems
AH-10 black 160		Plastic hoods decoration of supply and exhaust vents of public, residential and industrial ventilation systems
AH-10 brown 160		Plastic hoods decoration of supply and exhaust vents of public, residential and industrial ventilation systems
AH-10 grey 160		Plastic hoods decoration of supply and exhaust vents of public, residential and industrial ventilation systems

AH-10 terracotta 160		Plastic hoods decoration of supply and exhaust vents of public, residential and industrial ventilation systems
AH-10 white 160		Plastic hoods decoration of supply and exhaust vents of public, residential and industrial ventilation systems
AH-11 vintage 160		Plastic hoods decoration of supply and exhaust vents of public, residential and industrial ventilation systems
AH-11 black 160		Plastic hoods decoration of supply and exhaust vents of public, residential and industrial ventilation systems
AH-11 brown 160		Plastic hoods decoration of supply and exhaust vents of public, residential and industrial ventilation systems
AH-11 grey 160		Plastic hoods decoration of supply and exhaust vents of public, residential and industrial ventilation systems
AH-11 terracotta 160		Plastic hoods decoration of supply and exhaust vents of public, residential and industrial ventilation systems
AH-11 white 160		Plastic hoods decoration of supply and exhaust vents of public, residential and industrial ventilation systems
AH-S chrome 160		Stainless steel ventilation hood
AH-S white 160		Stainless steel ventilation hood
PP 160/0.5		The outer hood is designed to prevent the ingress of water and large objects into the ventilation equipment from outside