



# Vento Eco Komfort Pro

Heat recovery single-room units. Maximum air flow up to 50 m<sup>3</sup>/h

- Air flow in heat recovery mode: 25
- Sound pressure level LpA at 3 m: 26
- Sound pressure level LpA at 1 m: 35
- Heat exchanger type: Regenerative
- Filter: G3 (Option: F8 PM2.5 > 99 %)
- Motor type: EC
- Control: Wired control panel
- Casing material: Plastic



	Unit of measurement	Vento Eco Komfort Pro		
Speed	-	3		
Minimum supply voltage	V	100		
Maximum supply voltage	V	240		
Power supply frequency	Hz	50/60		
Rated power	W	2.00	3.5	5.5
Unit current	A	0.030	0.034	0.060
Air flow in ventilation mode	m <sup>3</sup> /h	15	35	50
Air flow in heat recovery mode	m <sup>3</sup> /h	8	15	25
rotation speed at 50hz	-	800	1300	1900
Sound pressure level LpA at 3 m	dB(A)	4	19	26
Sound pressure level LpA at 1 m	dB(A)	10	27	35
Heat recovery efficiency, max	%	95		
Heat exchanger type	-	Regenerative		
Heat exchanger material	-	Ceramic		
Filter	-	G3 (Option: F8 PM2.5 > 99 %)		
Transported air temperature (max)	°C	40		
Transported air temperature (min)	°C	-20		
Ingress protection rating	-	IP24		

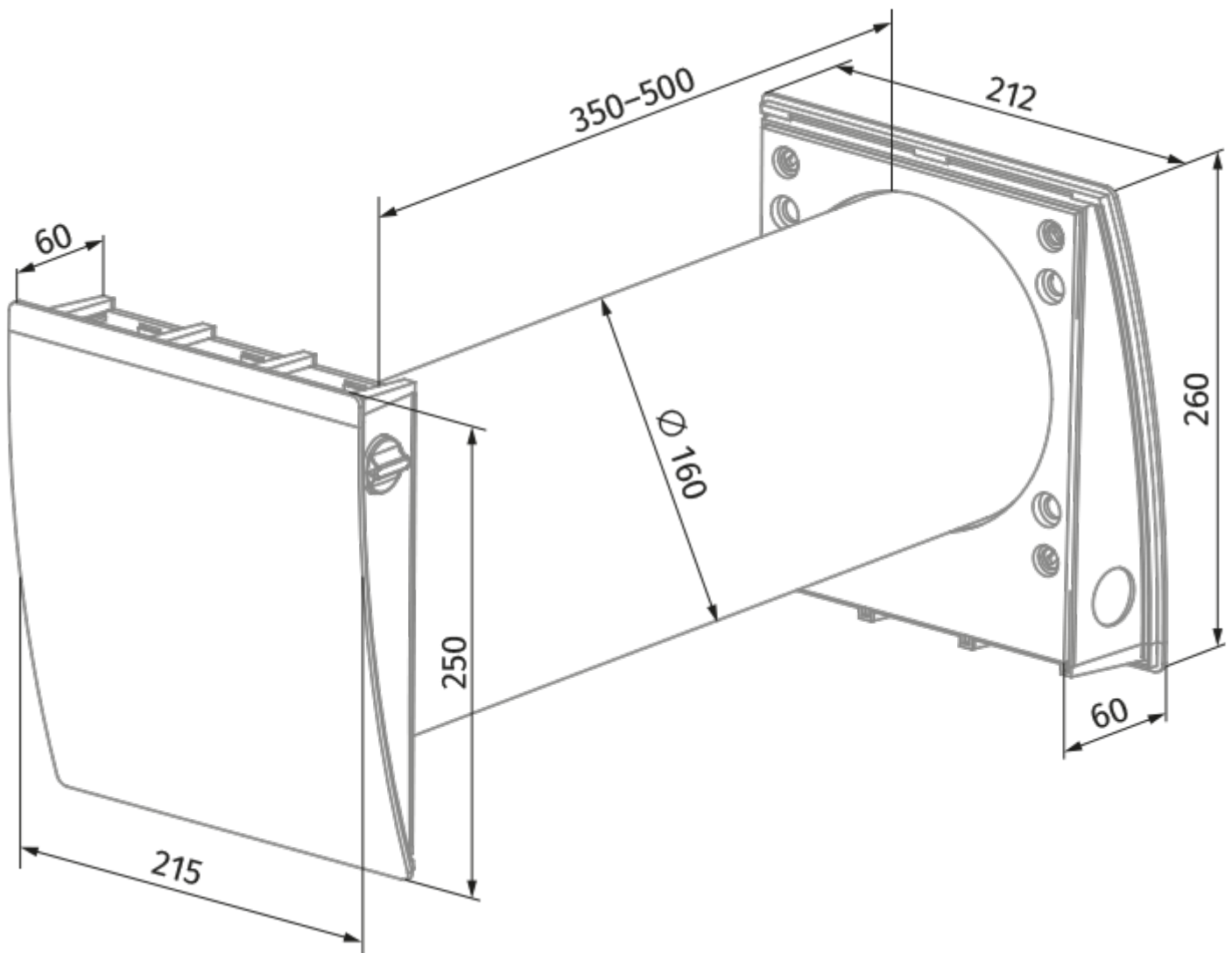



## Dimensions







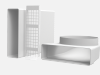

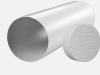
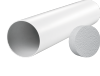
## Accessories





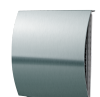



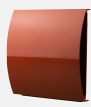

### Other accessories

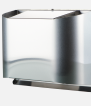
Name	Photo	Description
FP2 Vento F7		Fine filter F7 Includes: • plastic filter holder (1 pc.) • F7 fine filter (1 pc.). Filtration rate PM2.5 > 70 %
FP2 Vento G4		Coarse filter G4 Contents: • plastic filter holder (1 pc.) • G4 filter (1 pc.)
FP2 Vento G3		G3 filter kit (2 pcs.)

FPC 150x50 G4		Filter
FPC 150x50 F7		Filter
KIT BlauPlast white 160		Kit for angular mounting (for walls with standard thickness)
KIT BlauPlast chrome 160		Kit for angular mounting (for walls with standard thickness)
R 160-500		Air duct 160 mm and polystyrene foam plug
R 160-700		Air duct 160 mm and polystyrene foam plug

## Hoods

Name	Photo	Description
<a href="#">AH-8 white 160</a>		Outer ventilation hood with frost protection for a cold climate
<a href="#">AH-8 chrome 160</a>		Outer ventilation hood with frost protection for a cold climate
<a href="#">AH-10 chrome 160</a>		Plastic hoods decoration of supply and exhaust vents of public, residential and industrial ventilation systems
<a href="#">AH-10 black 160</a>		Plastic hoods decoration of supply and exhaust vents of public, residential and industrial ventilation systems
<a href="#">AH-10 beige 160</a>		Plastic hoods decoration of supply and exhaust vents of public, residential and industrial ventilation systems
<a href="#">AH-10 brown 160</a>		Plastic hoods decoration of supply and exhaust vents of public, residential and industrial ventilation systems
<a href="#">AH-10 grey 160</a>		Plastic hoods decoration of supply and exhaust vents of public, residential and industrial ventilation systems

<a href="#">AH-10 terracotta 160</a>		Plastic hoods decoration of supply and exhaust vents of public, residential and industrial ventilation systems
<a href="#">AH-10 white 160</a>		Plastic hoods decoration of supply and exhaust vents of public, residential and industrial ventilation systems
AH-S chrome 160		Stainless steel ventilation hood
<a href="#">AH-11 vintage 160</a>		Plastic hoods decoration of supply and exhaust vents of public, residential and industrial ventilation systems
<a href="#">AH-11 black 160</a>		Plastic hoods decoration of supply and exhaust vents of public, residential and industrial ventilation systems
<a href="#">AH-11 brown 160</a>		Plastic hoods decoration of supply and exhaust vents of public, residential and industrial ventilation systems
<a href="#">AH-11 grey 160</a>		Plastic hoods decoration of supply and exhaust vents of public, residential and industrial ventilation systems
<a href="#">AH-11 terracotta 160</a>		Plastic hoods decoration of supply and exhaust vents of public, residential and industrial ventilation systems
<a href="#">AH-11 white 160</a>		Plastic hoods decoration of supply and exhaust vents of public, residential and industrial ventilation systems
AH-S white 160		Stainless steel ventilation hood
<a href="#">PP 160/0.5</a>		The outer hood is designed to prevent the ingress of water and large objects into the ventilation equipment from outside