

## VENTO Eco A30-4 S11 Pro

Heat recovery single-room units. Maximum air flow up to 30 m<sup>3</sup>/h.

- Air flow in heat recovery mode: 15
- Sound pressure level LpA at 3 m: 31
- Sound pressure level LpA at 1 m: 40
- Heat exchanger type: Regenerative
- Motor type: EC
- Control: Wired control panel
- Casing material: Plastic

	Unit of measurement	VENTO Eco A30-4 S11 Pro		
Speed	-	3		
Minimum supply voltage	V	100		
Maximum supply voltage	V	240		
Power supply frequency	Hz	50/60		
Rated power	W	1.03	1.96	3.47
Unit current	A	0.021	0.027	0.038
Air flow in ventilation mode	m <sup>3</sup> /h	10	20	30
Air flow in heat recovery mode	m <sup>3</sup> /h	5	10	15
rotation speed at 50hz	-	1600	2200	2500
Sound pressure level LpA at 3 m	dB(A)	21	28	31
Sound pressure level LpA at 1 m	dB(A)	30	37	40
Heat recovery efficiency, max	%	81		
Heat exchanger type	-	Regenerative		
Heat exchanger material	-	Ceramic		
Transported air temperature (max)	°C	40		
Transported air temperature (min)	°C	-20		
Ingress protection rating	-	IP24		

## Dimensions

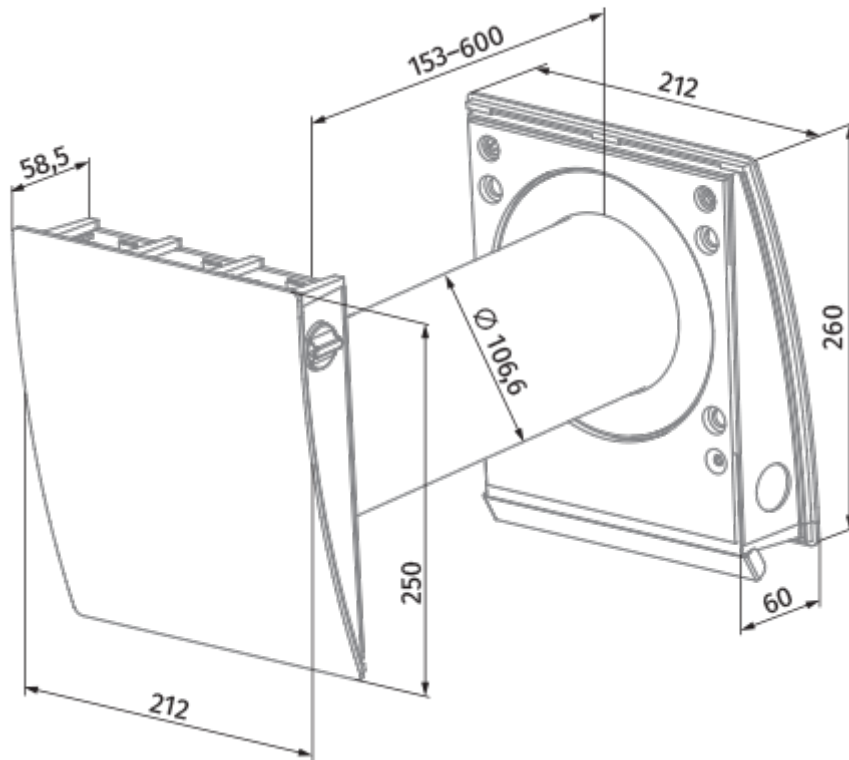

## Ecodesign



Trademark	Blauberg					
Model	VENTO Eco A30-4 S11 Pro					
Specific energy consumption (SEC) (kWh/(m <sup>2</sup> /a))	Cold		Average		Warm	
	-72.7	A+	-34.1	A	-12	E
Type of ventilation unit	Bidirectional					
Type of drive installed	3-speed					
Type of heat recovery system	Regenerative					
Thermal efficiency of heat recovery (%)	74					
Maximum flow rate (m <sup>3</sup> /h)	15					
Electric power input (W)	3.47					
Reference flow rate (m <sup>3</sup> /s)	0.003					
Specific power input (SPI) (W/(m <sup>3</sup> /h))	0.196					
Control typology	Clock control					
Airflow sensitivity at +20 Pa and -20 Pa (%)	0.4					
Sound power level (dB(A))	47					
Declared typology	RVU BVU					
The annual electricity consumption (AEC) (kWh/a)	Cold		Average		Warm	
	250		250		250	













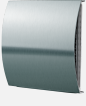

## Accessories

### Other accessories

Name	Photo	Description
FP2 Vento G3		G3 filter kit (2 pcs.)
KIT BlauPlast white 100		Kit for angular mounting (for walls with standard thickness)
KIT BlauPlast chrome 100		Kit for angular mounting (for walls with standard thickness)

### Hoods

Name	Photo	Description
------	-------	-------------

AH-8 white 100		Outer ventilation hood with frost protection for a cold climate
AH-8 chrome 100		Outer ventilation hood with frost protection for a cold climate
<a href="#">AH-10 beige 100</a>		Plastic hoods decoration of supply and exhaust vents of public, residential and industrial ventilation systems
<a href="#">AH-10 black 100</a>		Plastic hoods decoration of supply and exhaust vents of public, residential and industrial ventilation systems
<a href="#">AH-10 brown 100</a>		Plastic hoods decoration of supply and exhaust vents of public, residential and industrial ventilation systems
<a href="#">AH-10 chrome 100</a>		Plastic hoods decoration of supply and exhaust vents of public, residential and industrial ventilation systems
<a href="#">AH-10 grey 100</a>		Plastic hoods decoration of supply and exhaust vents of public, residential and industrial ventilation systems
<a href="#">AH-10 terracotta 100</a>		Plastic hoods decoration of supply and exhaust vents of public, residential and industrial ventilation systems
<a href="#">AH-10 white 100</a>		Plastic hoods decoration of supply and exhaust vents of public, residential and industrial ventilation systems
<a href="#">AH-11 vintage 100</a>		Plastic hoods decoration of supply and exhaust vents of public, residential and industrial ventilation systems
<a href="#">AH-11 black 100</a>		Plastic hoods decoration of supply and exhaust vents of public, residential and industrial ventilation systems
<a href="#">AH-11 brown 100</a>		Plastic hoods decoration of supply and exhaust vents of public, residential and industrial ventilation systems
<a href="#">AH-11 grey 100</a>		Plastic hoods decoration of supply and exhaust vents of public, residential and industrial ventilation systems
<a href="#">AH-11 terracotta 100</a>		Plastic hoods decoration of supply and exhaust vents of public, residential and industrial ventilation systems
<a href="#">AH-11 white 100</a>		Plastic hoods decoration of supply and exhaust vents of public, residential and industrial ventilation systems

AH-S chrome 100		Stainless steel ventilation hood
AH-S white 100		Stainless steel ventilation hood

### Flat duct

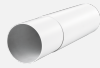
Name	Photo	Description
<a href="#">BlauPlast RTR 100/0.5-1</a>		Round telescopic duct
<a href="#">BlauPlast RTR 100/0.35-0.5</a>		Round telescopic duct