

Turbo 315 TW1

Mixed-flow inline fans



- Maximum airflow: 2050
- Sound pressure level LpA at 3 m: 52
- Motor type: AC
- Impeller type: Mixed-flow
- Casing material: Plastic
- Installation in any position
- Cable with mains plug
- Timer: Turn off timer

	Unit of measurement	Turbo 315 TW1	
Connected air duct size	mm	315	
Speed	-	2	
Minimum supply voltage	V	230	
Maximum supply voltage	V	230	
Power supply frequency	Hz	50/60	
Rated power	W	230	320
Unit current	A	1.0	1.42
Maximum airflow	m ³ /h	1570	2050
Sound pressure level LpA at 3 m	dB(A)	41	52
Weight	kg	11.95	
Transported air temperature (max)	°C	60	
Ingress protection rating	-	IPX4	
Ingress protection rating of the drive	-	IPX4	

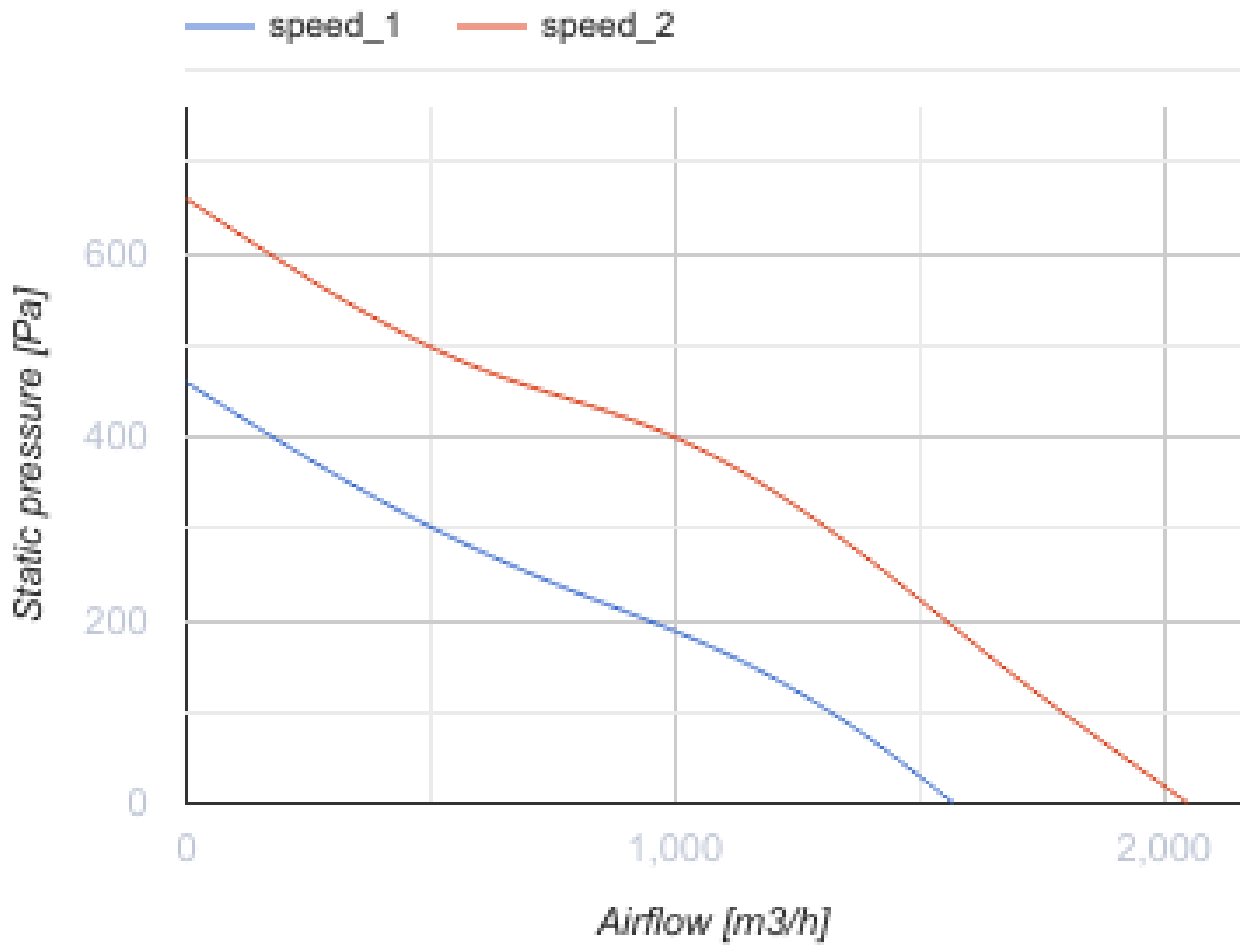

Dimensions

ØD	ØD1	B	H	L
310	323	362	408	445







Ecodesign

Trademark	Blauberg
Model	Turbo 315 TW1
Type of ventilation unit	Unidirectional
Type of drive installed	External MSD or VSD
Type of heat recovery system	None
Nominal flow rate (m ³ /s)	0.321
Nominal external pressure (Pa)	327
Maximum external leakage rates (%)	2.7
Static efficiency (%)	34.8
Declared typology	NRVU UVU
Effective electric power input (kW)	0.308
Sound power level (dB(A))	74



Accessories

Other accessories

Name	Photo	Description
IRSE / IRSI 1.5		Sensors
HSE / HSI 1.5		Sensors
TE / TI 1.5		Timers
LSE / LSI 1.5		Sensors

Other accessories

Name	Photo	Description
CDP-2/10		Multi-speed switch

CDT E1.8		Thyristor speed controller
CDT E0.5		Thyristor speed controller
MLCD E2		Room temperature regulator