

Turbo 250 W1

Inline mixed-flow fans



- Maximum airflow: 1400
- Sound pressure level LpA at 3 m: 51
- Motor type: AC
- Impeller type: Mixed-flow
- Casing material: Plastic
- Installation in any position
- Cable with mains plug

	Unit of measurement	Turbo 250 W1	
Connected air duct size	mm	250	
Speed	-	2	
Minimum supply voltage	V	230	
Maximum supply voltage	V	230	
Power supply frequency	Hz	50/60	
Rated power	W	125	177
Unit current	A	0.54	0.79
Maximum airflow	m ³ /h	1110	1400
Sound pressure level LpA at 3 m	dB(A)	44	51
Weight	kg	7.8	
Transported air temperature (max)	°C	60	
Ingress protection rating	-	IPX4	
Ingress protection rating of the drive	-	IPX4	

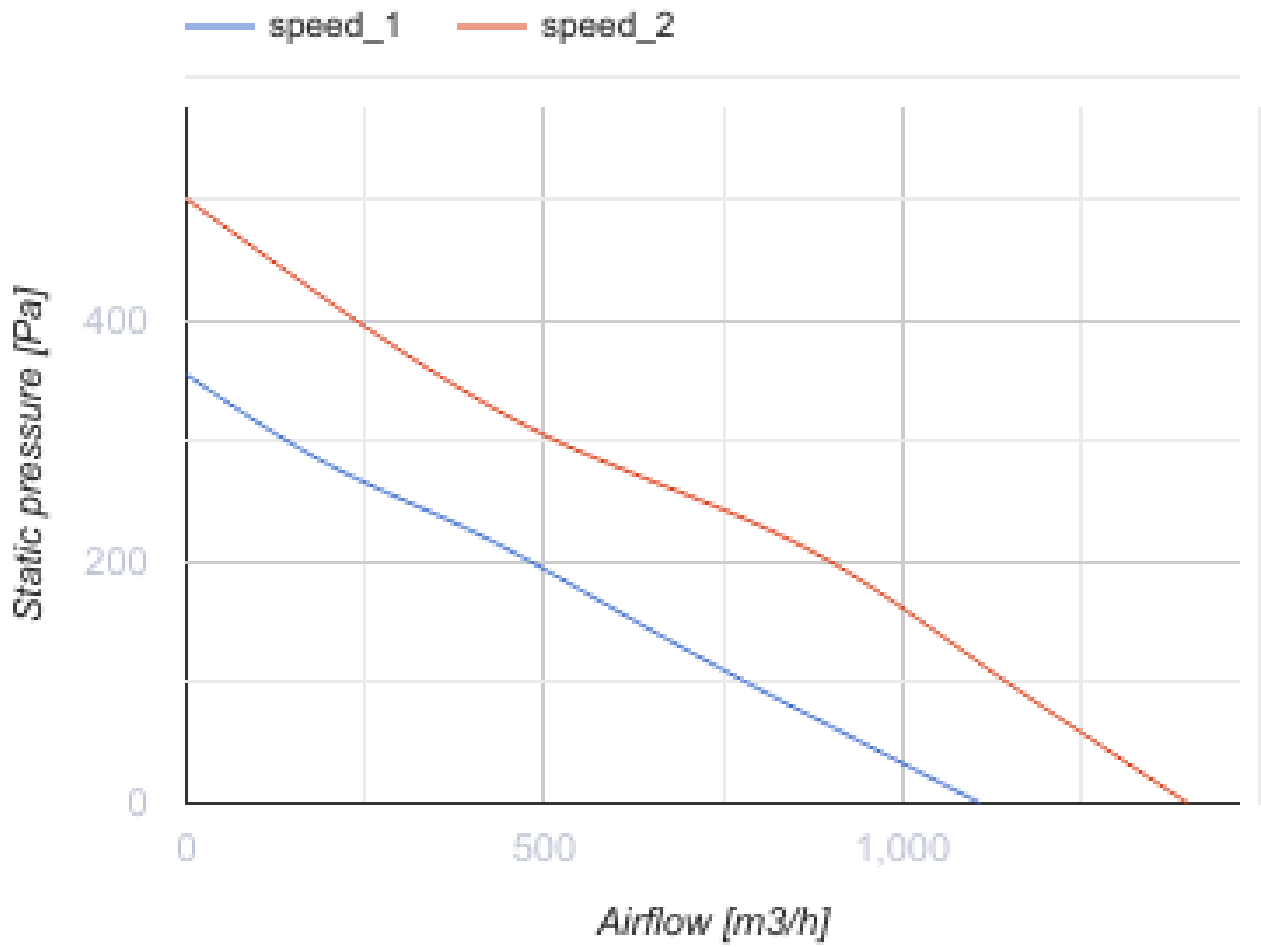

Dimensions

ØD	ØD1	B	H	L
247	257	287	323	383







Ecodesign

Trademark	Blauberg
Model	Turbo 250 W1
Type of ventilation unit	Unidirectional
Type of drive installed	External MSD or VSD
Type of heat recovery system	None
Nominal flow rate (m ³ /s)	0.206
Nominal external pressure (Pa)	247
Maximum external leakage rates (%)	2.7
Static efficiency (%)	31.5
Declared typology	NRVU UVU
Effective electric power input (kW)	0.165
Sound power level (dB(A))	72

Accessories

Humidity sensors



Name	Photo	Description
IRSE / IRSI 1.5		Sensors
HSE / HSI 1.5		Sensors
TE / TI 1.5		Timers
LSE / LSI 1.5		Sensors

Speed control switches

Name	Photo	Description
------	-------	-------------

CDP-2/10		Multi-speed switch
--------------------------	---	--------------------

Thyristor speed controllers

Name	Photo	Description
CDT E1.8		Thyristor speed controller
CDT E0.5		Thyristor speed controller

Temperature controllers

Name	Photo	Description
MLCD E2		Room temperature regulator