



Turbo 200 TUSW1

Inline mixed-flow fans

- Maximum airflow: 1040
- Sound pressure level LpA at 3 m: 45
- Motor type: AC
- Control: Built-in speed controller
- Impeller type: Mixed-flow
- Casing material: Plastic
- Installation in any position
- Cable with mains plug
- Timer: Turn off timer

	Unit of measurement	Turbo 200 TUSW1	
Connected air duct size	mm	200	
Speed	-	2	
Minimum supply voltage	V	230	
Maximum supply voltage	V	230	
Power supply frequency	Hz	50/60	
Rated power	W	76	108
Unit current	A	0.34	0.48
Maximum airflow	m ³ /h	830	1040
Sound pressure level LpA at 3 m	dB(A)	39	45
Weight	kg	3.95	
Transported air temperature (max)	°C	60	
Ingress protection rating	-	IPX4	
Ingress protection rating of the drive	-	IPX4	

Dimensions

ØD	ØD1	B	H	L
199	209	239	261	295.5



Ecodesign

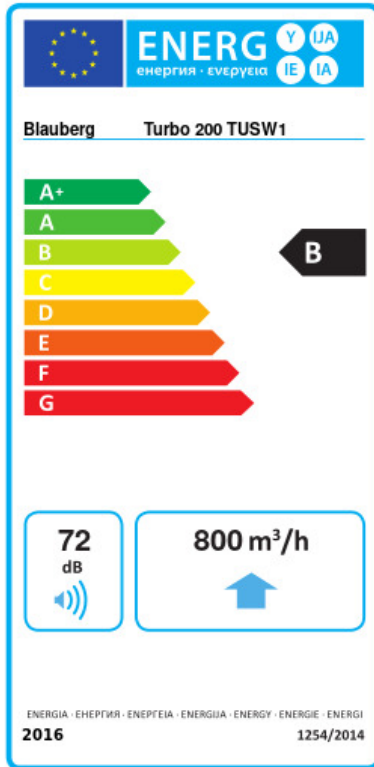

Trademark	Blauberg					
Model	Turbo 200 TUSW1					
Specific energy consumption (SEC) (kWh/(m²/a))	Cold		Average		Warm	
	-53.6	A+	-26.5	B	-11	E
Type of ventilation unit	Unidirectional					
Type of drive installed	Variable speed					
Type of heat recovery system	None					
Maximum flow rate (m³/h)	800					
Electric power input (W)	108					
Reference flow rate (m³/s)	0.156					
Reference pressure difference (Pa)	50					
Specific power input (SPI) (W/(m³/h))	0.136					
Control typology	Local demand control					
Maximum external leakage rates (%)	2.7					
Sound power level (dB(A))	72					
Declared typology	RVU UVU					
The annual electricity consumption (AEC) (kWh/a)	Cold		Average		Warm	
	72		72		72	
The annual heating saved (AHS) (kWh/a)	Cold		Average		Warm	
	5536		2830		1280	

Accessories

Humidity sensors



Name	Photo	Description
IRSE / IRSI 1.5		Sensors
HSE / HSI 1.5		Sensors
TE / TI 1.5		Timers

LSE / LSI 1.5		Sensors
-------------------------------	---	---------

Speed control switches

Name	Photo	Description
CDP-2/10		Multi-speed switch

Thyristor speed controllers

Name	Photo	Description
CDT E1.8		Thyristor speed controller
CDT E0.5		Thyristor speed controller

Temperature controllers

Name	Photo	Description
MLCD E2		Room temperature regulator