

# Turbo 200 G1

Inline mixed-flow fans



- Maximum airflow: 1040
- Sound pressure level LpA at 3 m: 45
- Motor type: AC
- Control: Built-in speed controller
- Impeller type: Mixed-flow
- Casing material: Plastic
- Installation in any position
- Cable with mains plug
- Temperature sensor

	Unit of measurement	Turbo 200 G1	
Connected air duct size	mm	200	
Speed	-	2	
Minimum supply voltage	V	230	
Maximum supply voltage	V	230	
Power supply frequency	Hz	50/60	
Rated power	W	76	108
Unit current	A	0.34	0.48
Maximum airflow	m <sup>3</sup> /h	830	1040
Sound pressure level LpA at 3 m	dB(A)	39	45
Weight	kg	3.95	
Transported air temperature (max)	°C	60	
Ingress protection rating	-	IPX4	
Ingress protection rating of the drive	-	IPX4	

## Dimensions

ØD	ØD1	B	H	L
199	209	239	261	295.5



## Ecodesign

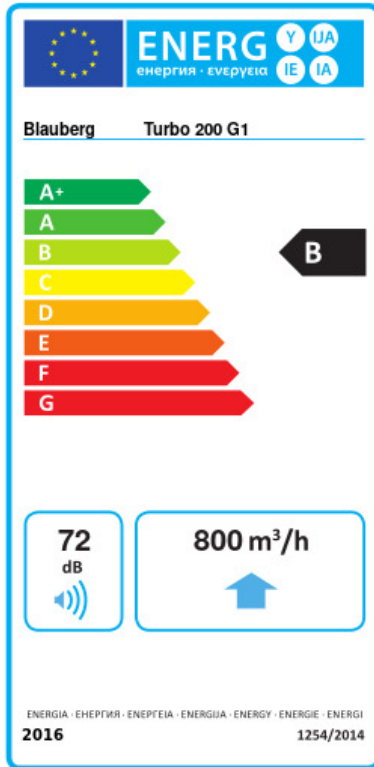

Trademark	Blauberg			
Model	Turbo 200 G1			
Specific energy consumption (SEC) (kWh/(m <sup>2</sup> /a))	Cold		Average	
	-53.6	A+	-26.5	B
Type of ventilation unit	Unidirectional			
Type of drive installed	Variable speed			
Type of heat recovery system	None			
Maximum flow rate (m <sup>3</sup> /h)	800			
Electric power input (W)	108			
Reference flow rate (m <sup>3</sup> /s)	0.156			
Reference pressure difference (Pa)	50			
Specific power input (SPI) (W/(m <sup>3</sup> /h))	0.136			
Control typology	Local demand control			
Maximum external leakage rates (%)	2.7			
Sound power level (dB(A))	72			
Declared typology	RVU UVU			
The annual electricity consumption (AEC) (kWh/a)	Cold		Average	
	72		72	
The annual heating saved (AHS) (kWh/a)	Cold		Average	
	5536		2830	1280

## Accessories

### Humidity sensors



Name	Photo	Description
<a href="#">IRSE / IRSI 1.5</a>		Sensors
<a href="#">HSE / HSI 1.5</a>		Sensors
<a href="#">TE / TI 1.5</a>		Timers

<a href="#">LSE / LSI 1.5</a>		Sensors
-------------------------------	---	---------

### Speed control switches

Name	Photo	Description
<a href="#">CDP-2/10</a>		Multi-speed switch

### Thyristor speed controllers

Name	Photo	Description
<a href="#">CDT E1.8</a>		Thyristor speed controller
<a href="#">CDT E0.5</a>		Thyristor speed controller

### Temperature controllers

Name	Photo	Description
<a href="#">MLCD E2</a>		Room temperature regulator