



Turbo 125 US

Inline mixed-flow fans

- Maximum airflow: 350
- Sound pressure level LpA at 3 m: 34
- Motor type: AC
- Control: Built-in speed controller
- Impeller type: Mixed-flow
- Casing material: Plastic
- Installation in any position

	Unit of measurement	Turbo 125 US	
Connected air duct size	mm	125	
Speed	-	2	
Minimum supply voltage	V	230	
Maximum supply voltage	V	230	
Power supply frequency	Hz	50/60	
Rated power	W	25	29
Unit current	A	0.11	0.13
Maximum airflow	m ³ /h	240	350
Sound pressure level LpA at 3 m	dB(A)	29	34
Weight	kg	2.15	
Transported air temperature (max)	°C	60	
Ingress protection rating	-	IPX4	
Ingress protection rating of the drive	-	IPX4	

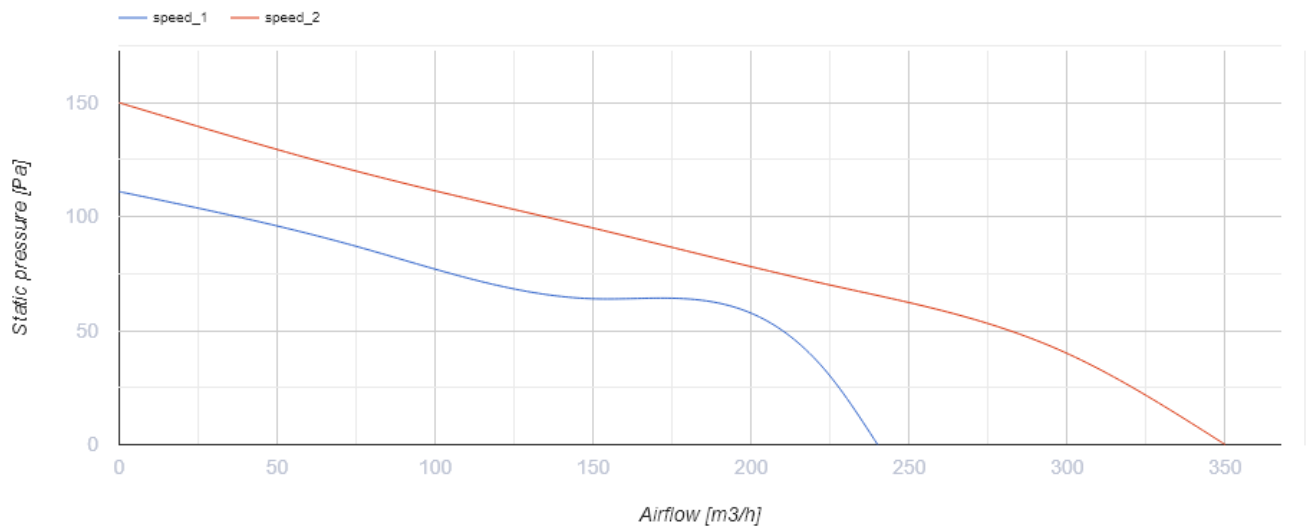

Dimensions

ØD	ØD1	B	H	L
123	164	196	241	258

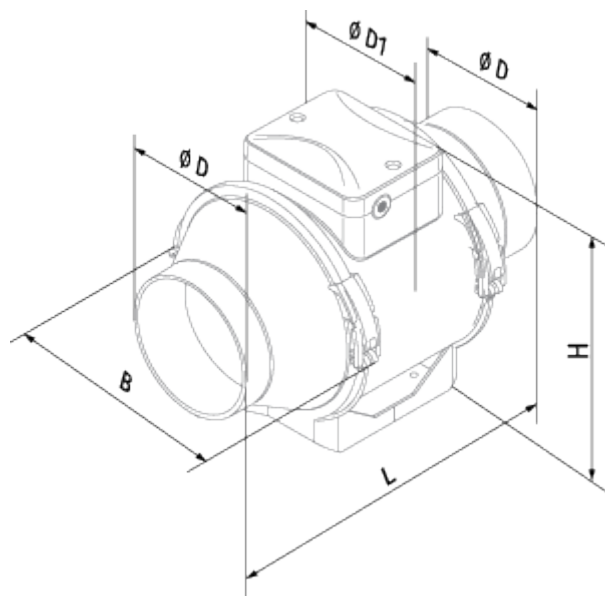

Ecodesign



Trademark	Blauberg					
Model	Turbo 125 US					
Specific energy consumption (SEC) (kWh/(m ² /a))	Cold		Average		Warm	
	-53.6	A+	-26.6	B	-11.1	E
Type of ventilation unit	Unidirectional					
Type of drive installed	Variable speed					
Type of heat recovery system	None					
Maximum flow rate (m ³ /h)	275					
Electric power input (W)	29					
Reference flow rate (m ³ /s)	0.053					
Reference pressure difference (Pa)	50					
Specific power input (SPI) (W/(m ³ /h))	0.13					
Control typology	Local demand control					
Maximum external leakage rates (%)	2.7					
Declared typology	RVU UVU					
Sound power level (dB(A))	54					
The annual electricity consumption (AEC) (kWh/a)	Cold		Average		Warm	
	69		69		69	
The annual heating saved (AHS) (kWh/a)	Cold		Average		Warm	
	5536		2830		1280	

Accessories

Temperature controllers

Name	Photo	Description
MLCD E2		Room temperature regulator

Thyristor speed controllers





Name	Photo	Description
CDT E0.5		Thyristor speed controller

CDT E1.8		Thyristor speed controller
--------------------------	---	----------------------------

Speed control switches

Name	Photo	Description
CDP-2/10		Multi-speed switch

Humidity sensors

Name	Photo	Description
TE / TI 1.5		Timers
HSE / HSI 1.5		Sensors
IRSE / IRSI 1.5		Sensors
LSE / LSI 1.5		Sensors