



Turbo 125 FR1

Mixed-flow inline fans

- Maximum airflow: 350
- Sound pressure level LpA at 3 m: 34
- Motor type: AC
- Control: Built-in speed controller
- Impeller type: Mixed-flow
- Casing material: Plastic
- Installation in any position
- Cable with mains plug

	Unit of measurement	Turbo 125 FR1	
Connected air duct size	mm	125	
Speed	-	2	
Minimum supply voltage	V	230	
Maximum supply voltage	V	230	
Power supply frequency	Hz	50/60	
Rated power	W	25	29
Unit current	A	0.11	0.13
Maximum airflow	m ³ /h	240	350
Sound pressure level LpA at 3 m	dB(A)	29	34
Weight	kg	2.15	
Transported air temperature (max)	°C	60	
Ingress protection rating	-	IPX4	
Ingress protection rating of the drive	-	IPX4	

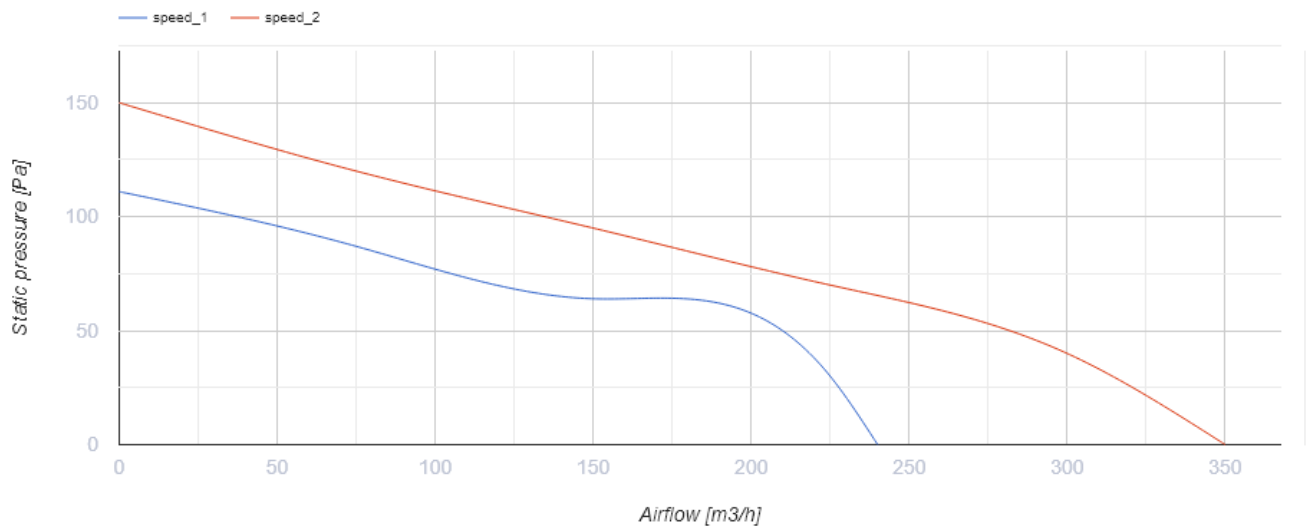

Dimensions

ØD	ØD1	B	H	L
123	164	196	241	258

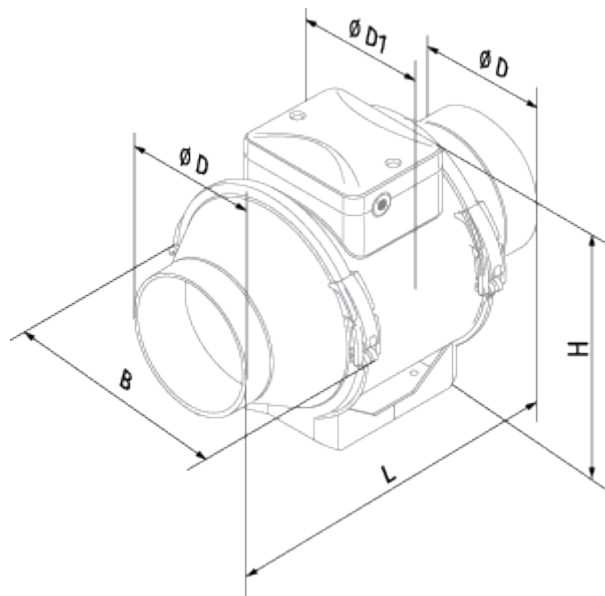



Ecodesign



Trademark	Blauberg					
Model	Turbo 125 FR1					
Specific energy consumption (SEC) (kWh/(m ² /a))	Cold		Average		Warm	
	-53.6	A+	-26.6	B	-11.1	E
Type of ventilation unit	Unidirectional					
Type of drive installed	Variable speed					
Type of heat recovery system	None					
Maximum flow rate (m ³ /h)	275					
Electric power input (W)	29					
Reference flow rate (m ³ /s)	0.053					
Reference pressure difference (Pa)	50					
Specific power input (SPI) (W/(m ³ /h))	0.13					
Control typology	Local demand control					
Maximum external leakage rates (%)	2.7					
Declared typology	RVU UVU					
Sound power level (dB(A))	54					
The annual electricity consumption (AEC) (kWh/a)	Cold		Average		Warm	
	69		69		69	
The annual heating saved (AHS) (kWh/a)	Cold		Average		Warm	
	5536		2830		1280	





Accessories

Other accessories

Name	Photo	Description
MLCD E2		Room temperature regulator
CDT E0.5		Thyristor speed controller
CDT E1.8		Thyristor speed controller

CDP-2/10		Multi-speed switch
--------------------------	---	--------------------

Other accessories

Name	Photo	Description
TE / TI 1.5		Timers
HSE / HSI 1.5		Sensors
IRSE / IRSI 1.5		Sensors
LSE / LSI 1.5		Sensors