

Tower-V EC 250

Roof centrifugal fans with EC motor

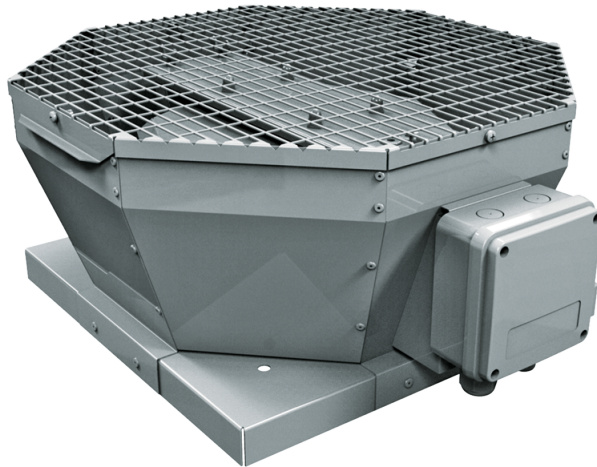

- Maximum airflow: 1470
- Sound pressure level LpA at 3 m: 54
- Motor type: EC
- Impeller type: Centrifugal backward curved blades
- Casing material: Coated steel

	Unit of measurement	Tower-V EC 250
Speed	-	1
Minimum supply voltage	V	230
Maximum supply voltage	V	230
Power supply frequency	Hz	50/60
Rated power	W	161
Unit current	A	1.29
Maximum airflow	m ³ /h	1470
Sound pressure level LpA at 3 m	dB(A)	54
Weight	kg	13
Transported air temperature (max)	°C	60
Transported air temperature (min)	°C	-25
Ingress protection rating	-	IPX4
Ingress protection rating of the drive	-	IP55

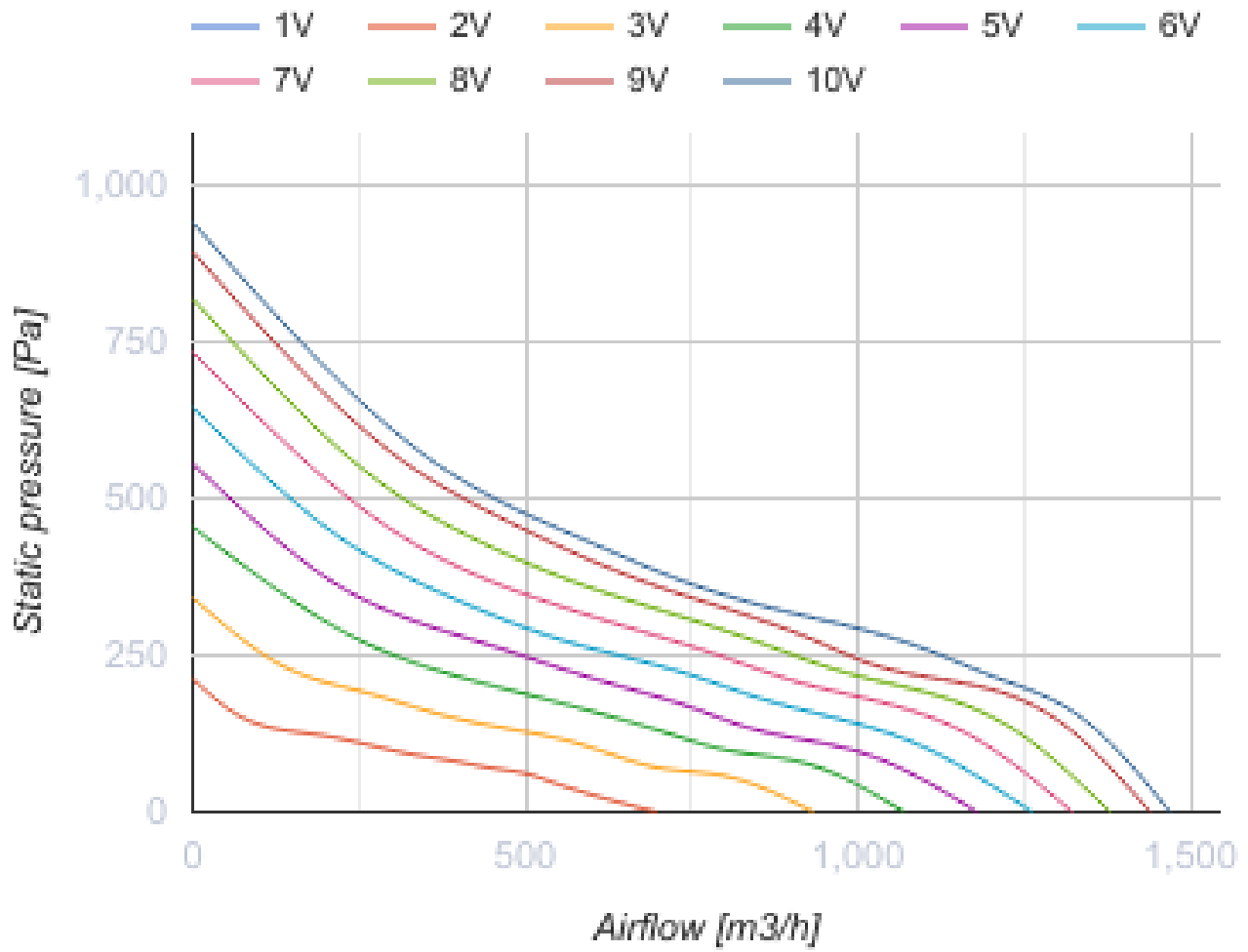

Dimensions

L	L1	H	L2
481	425	236	53

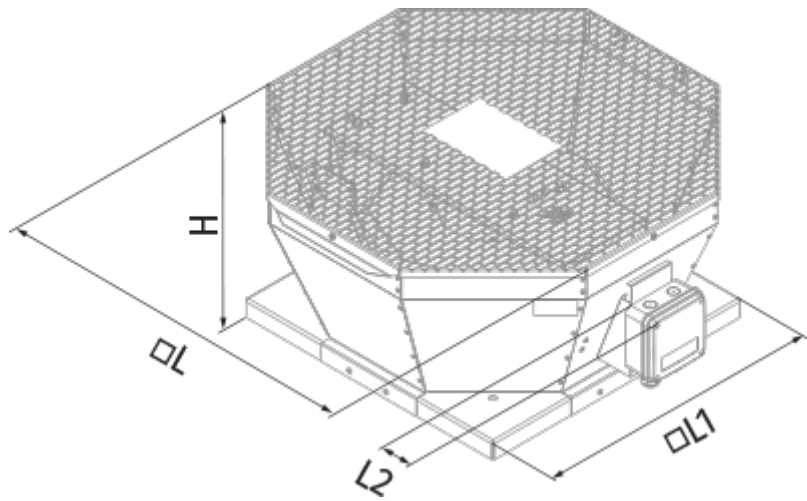

Ecodesign

Trademark	Blauberg
Model	Tower-V EC 250
Type of ventilation unit	Unidirectional
Type of drive installed	Integrated VSD
Type of heat recovery system	None
Nominal flow rate (m ³ /s)	0.336
Nominal external pressure (Pa)	606
Maximum external leakage rates (%)	2.7
Static efficiency (%)	47.6
Declared typology	NRVU UVU
Sound power level (dB(A))	67
Effective electric power input (kW)	0.485

Accessories

EC motors regulators

Name	Photo	Description
CDT E/0-10		Speed control for EC motors