

# Tower-V EC 225

Roof centrifugal fans with EC motor

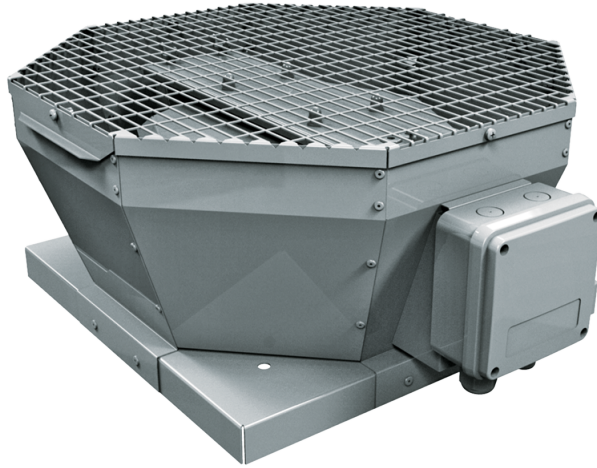

- Maximum airflow: 1290
- Sound pressure level LpA at 3 m: 47
- Motor type: EC
- Impeller type: Centrifugal backward curved blades
- Casing material: Coated steel

	Unit of measurement	Tower-V EC 225
Speed	-	1
Minimum supply voltage	V	230
Maximum supply voltage	V	230
Power supply frequency	Hz	50/60
Rated power	W	101
Unit current	A	0.8
Maximum airflow	m <sup>3</sup> /h	1290
Sound pressure level LpA at 3 m	dB(A)	47
Weight	kg	8
Transported air temperature (max)	°C	60
Transported air temperature (min)	°C	-25
Ingress protection rating	-	IPX4
Ingress protection rating of the drive	-	IP55

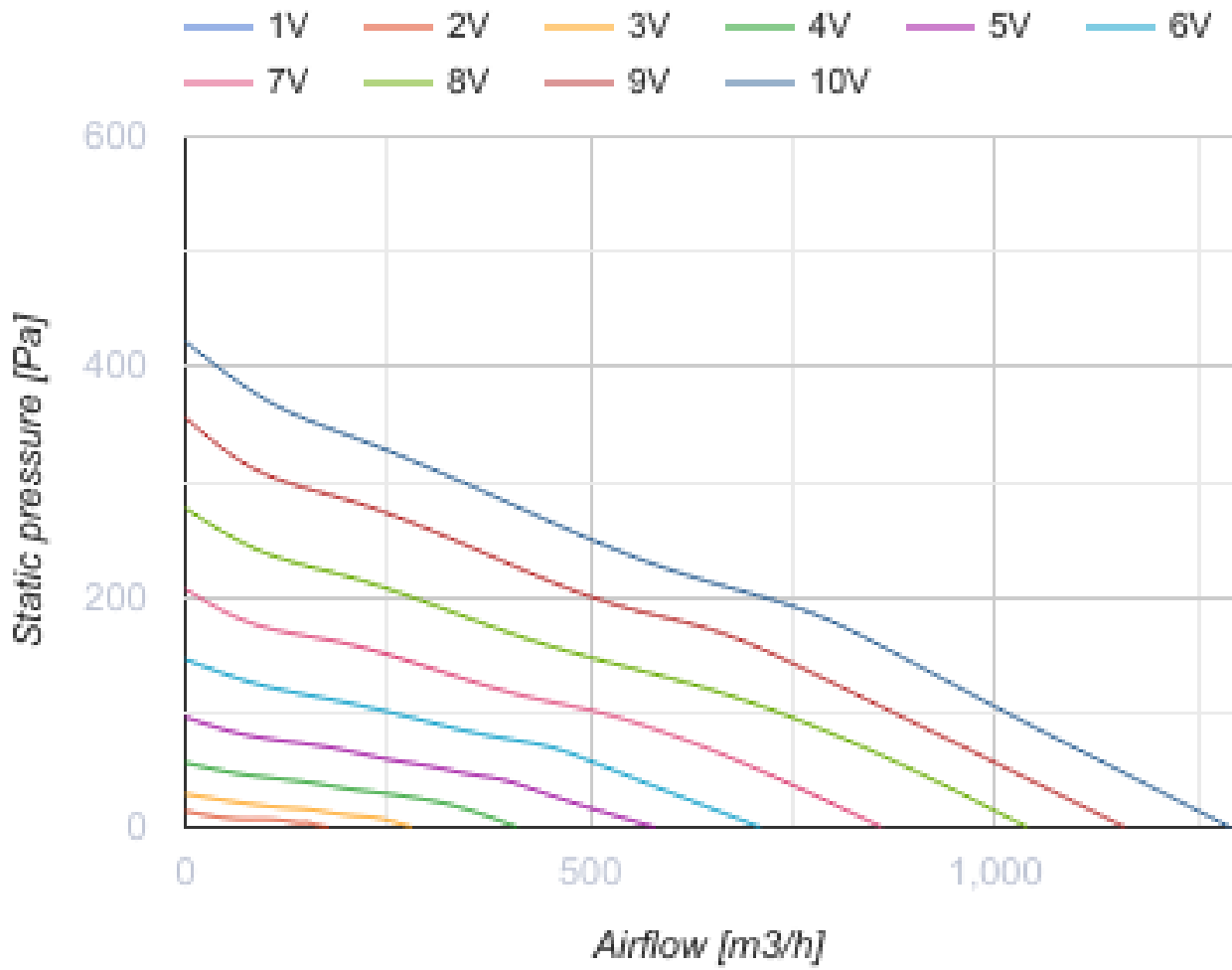

### Dimensions

L	L1	H	L2
417	355	210	53

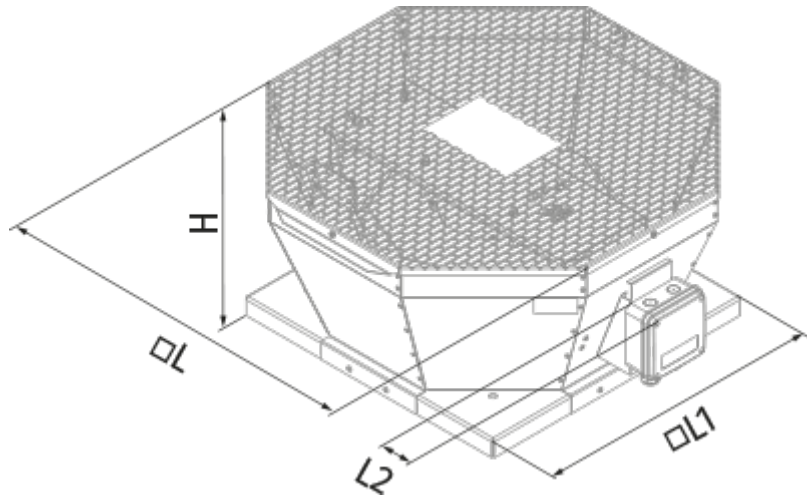

## Ecodesign

Trademark	Blauberg
Model	Tower-V EC 225
Type of ventilation unit	Unidirectional
Type of drive installed	Integrated VSD
Type of heat recovery system	None
Nominal flow rate (m <sup>3</sup> /s)	0.215
Nominal external pressure (Pa)	186
Maximum external leakage rates (%)	2.7
Static efficiency (%)	48.3
Declared typology	NRVU UVU
Sound power level (dB(A))	67
Effective electric power input (kW)	0.098

## Accessories

### Other accessories

Name	Photo	Description
<a href="#">CDT E/0-10</a>		Speed control for EC motors