

Tower-V 500 4D

Roof centrifugal fans

- Maximum airflow: 8435
- Sound pressure level LpA at 3 m: 62
- Motor type: AC
- Impeller type: Centrifugal backward curved blades
- Casing material: Coated steel



	Unit of measurement	Tower-V 500 4D
Speed	-	1
Minimum supply voltage	V	400
Maximum supply voltage	V	400
Power supply frequency	Hz	50
Rated power	W	1527
Unit current	A	2.64
Maximum airflow	m ³ /h	8435
Sound pressure level LpA at 3 m	dB(A)	62
Weight	kg	46.6
Transported air temperature (max)	°C	50
Transported air temperature (min)	°C	-30
Ingress protection rating	-	IPX4
Ingress protection rating of the drive	-	IP54

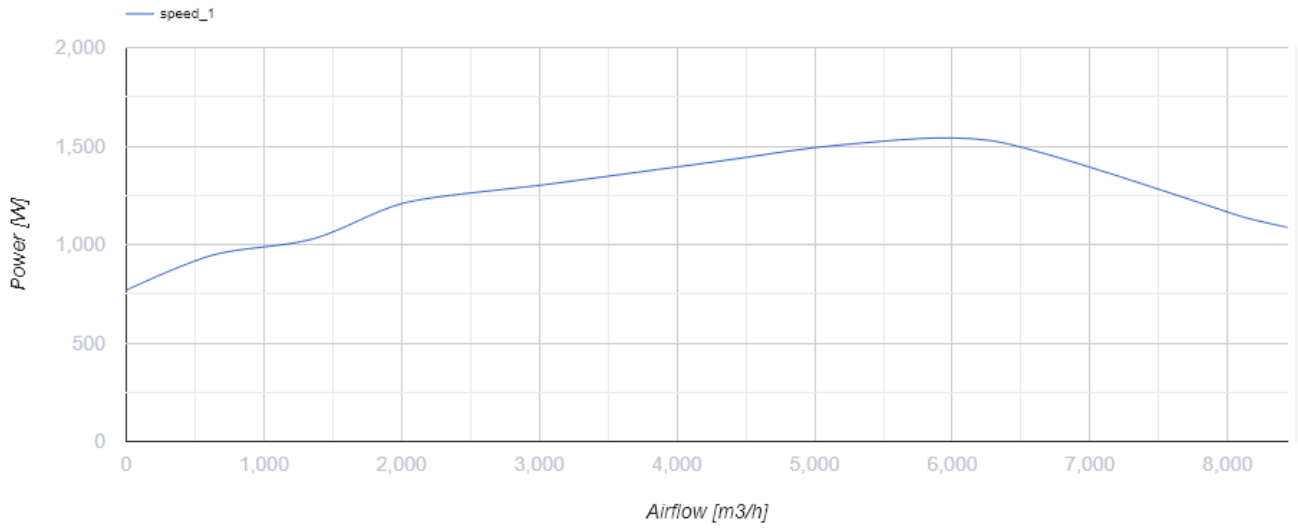
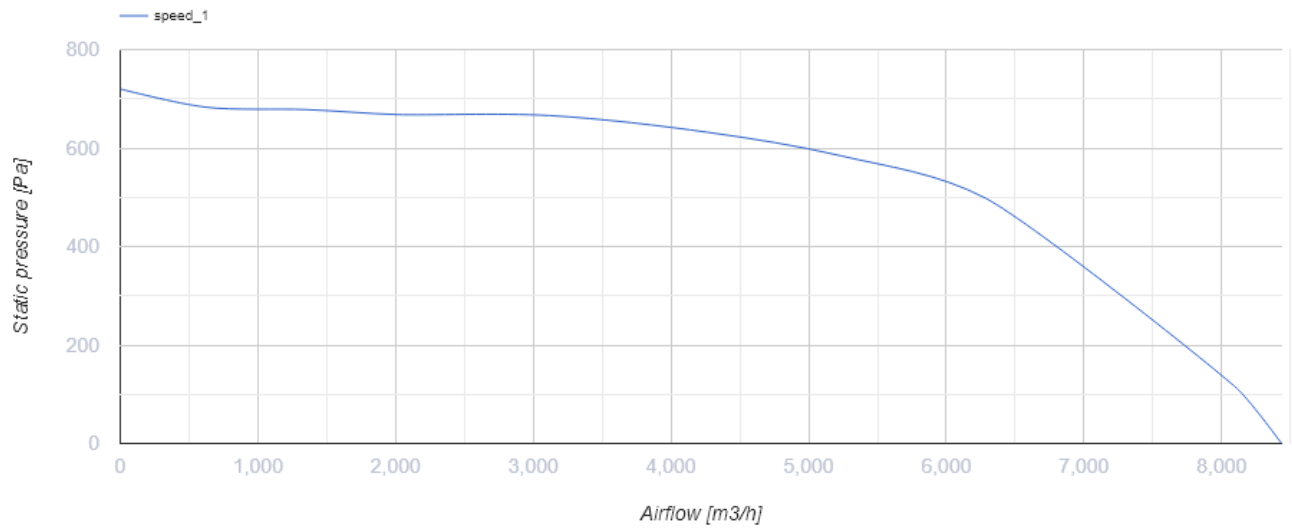

Dimensions

ØD	H	L	L1
430	460	859	668

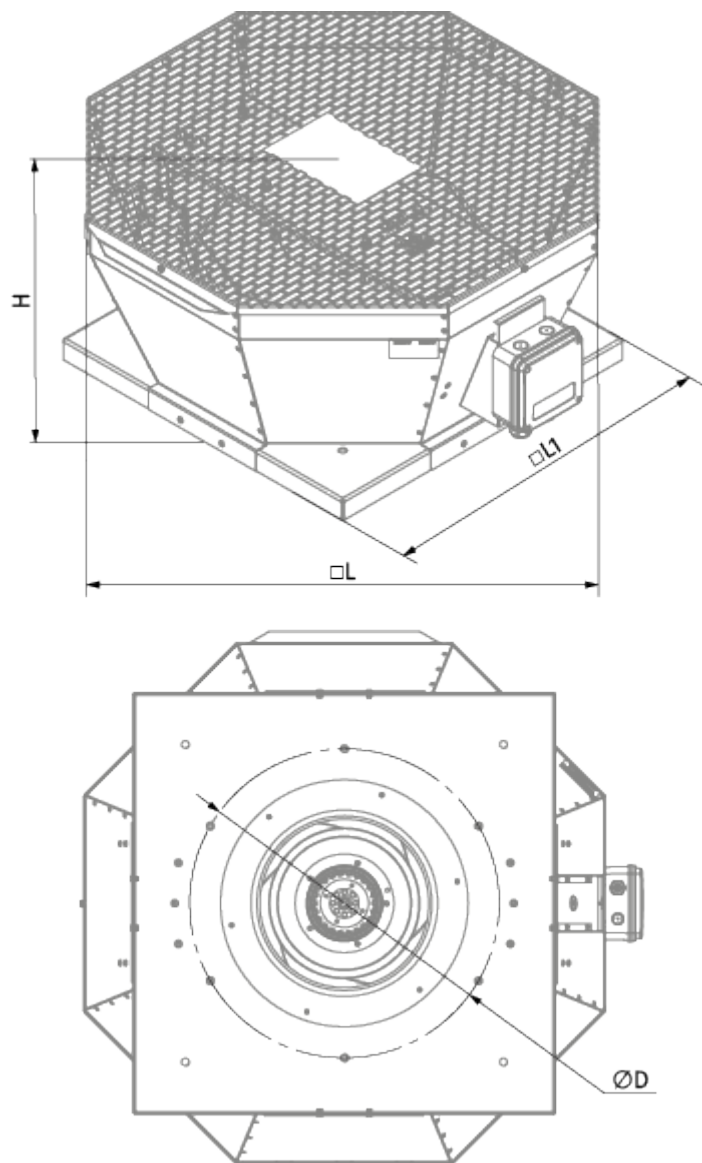

Accessories

Thyristor speed controllers

Name	Photo	Description
CDT E1.8		Thyristor speed controller