

# Tower-HC 250 2E

Roof centrifugal fans

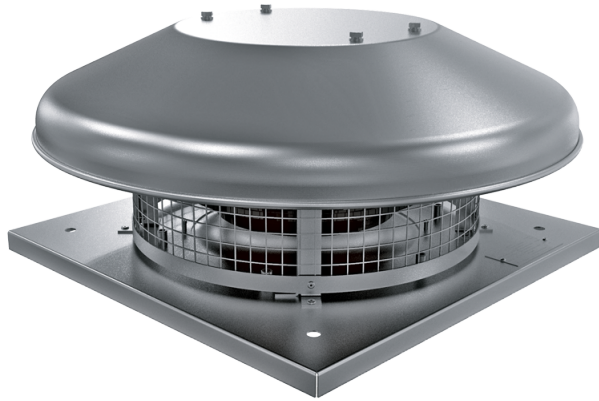

- Maximum airflow: 1485
- Sound pressure level LpA at 3 m: 54
- Motor type: AC
- Impeller type: Centrifugal backward curved blades
- Casing material: Coated steel

	Unit of measurement	Tower-HC 250 2E	
Speed	-	1	
Phases	-	1	
Minimum supply voltage	V	230	
Maximum supply voltage	V	230	
Power supply frequency	Hz	50	60
Rated power	W	184	
Unit current	A	0.81	
Maximum airflow	m <sup>3</sup> /h	1485	
rotation speed at 50hz	-	2480	
Sound pressure level LpA at 3 m	dB(A)	54	
Weight	kg	8	
Transported air temperature (max)	°C	50	
Transported air temperature (min)	°C	-25	
Ingress protection rating	-	IPX4	
Ingress protection rating of the drive	-	IP44	

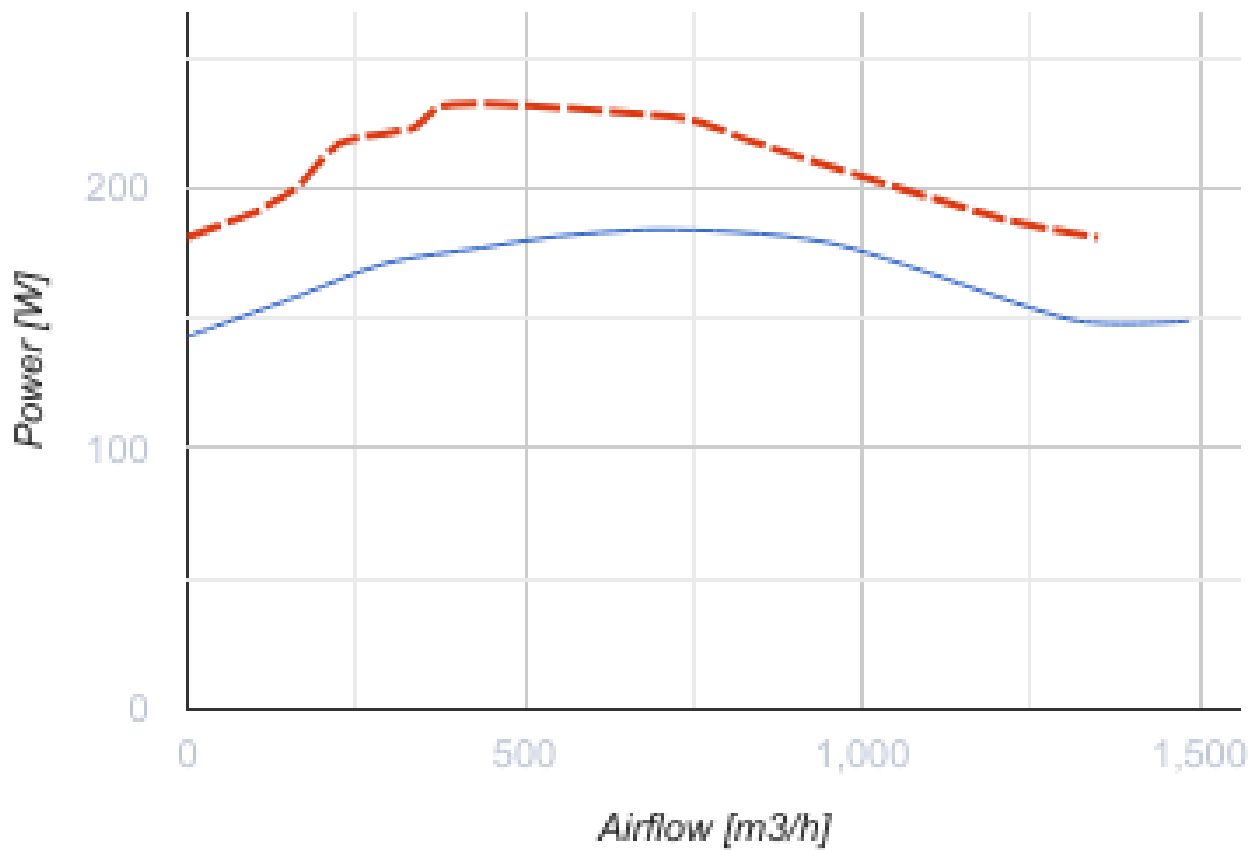
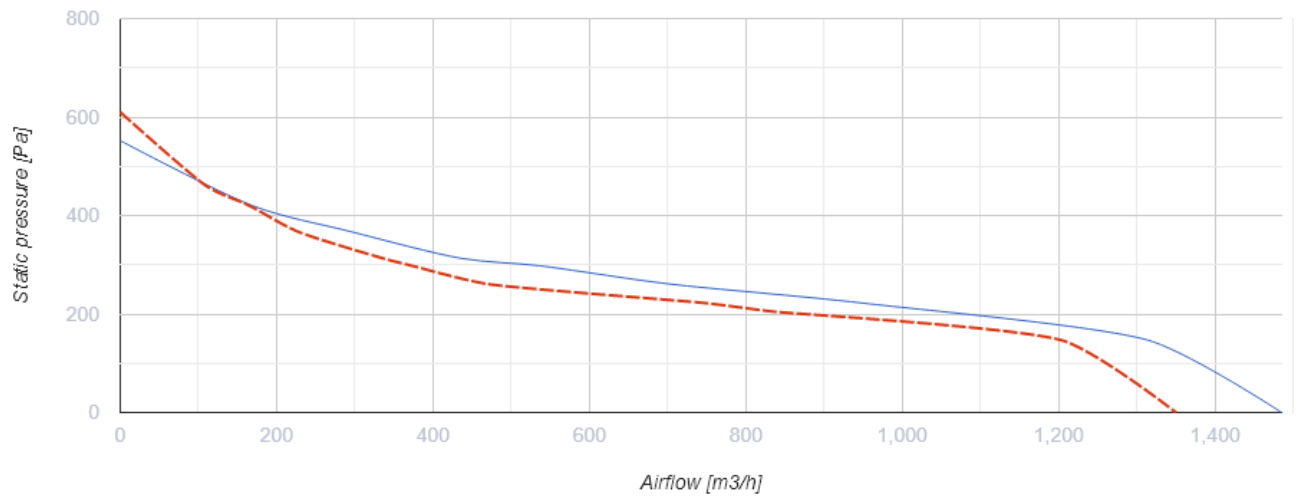

## Dimensions

H	ØD	ØD1	L	L1
224	503	285	420	330

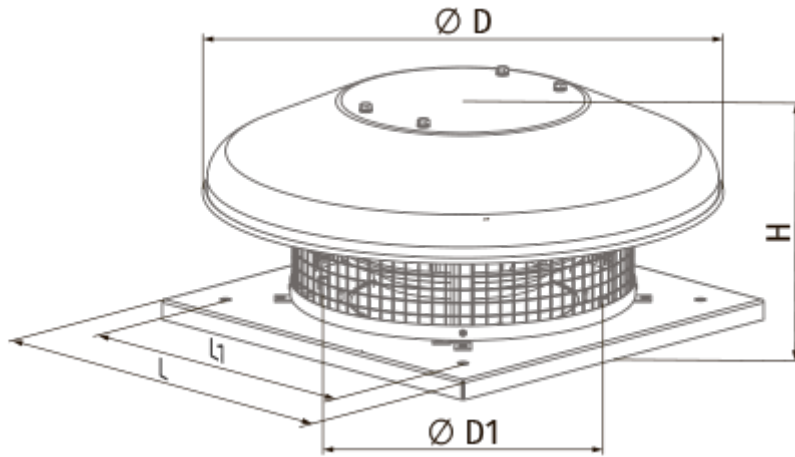

## Ecodesign

Trademark	Blauberg
Model	Tower-HC 250 2E
Type of drive installed	Integrated VSD
Type of heat recovery system	None
Nominal flow rate (m <sup>3</sup> /s)	0.367
Nominal external pressure (Pa)	144
Maximum external leakage rates (%)	2.7
Static efficiency (%)	41.4
Effective electric power input (kW)	0.149
Sound power level (dB(A))	67
Declared typology	NRVU UVU