

Tower-HC 220 2E

A

Roof centrifugal fans

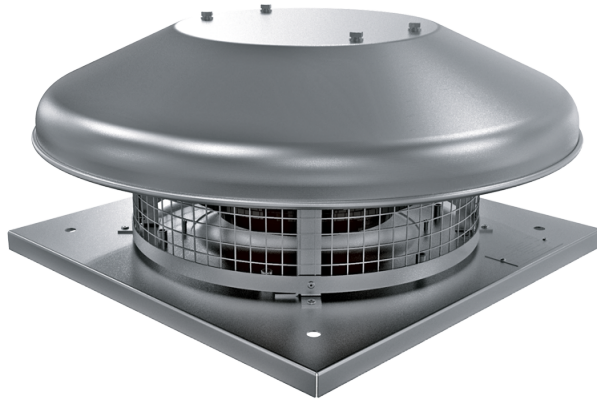

- Maximum airflow: 915
- Sound pressure level LpA at 3 m: 50
- Motor type: AC
- Impeller type: Centrifugal backward curved blades
- Casing material: Aluminium

	Unit of measurement	Tower-HC 220 2E A	
Speed	-	1	
Phases	-	1	
Minimum supply voltage	V	230	
Maximum supply voltage	V	230	
Power supply frequency	Hz	50	60
Rated power	W	108	
Unit current	A	0.49	
Maximum airflow	m ³ /h	915	
rotation speed at 50hz	-	2640	
Sound pressure level LpA at 3 m	dB(A)	50	
Weight	kg	8	
Transported air temperature (max)	°C	50	
Transported air temperature (min)	°C	-25	
Ingress protection rating	-	IPX4	
Ingress protection rating of the drive	-	IP44	

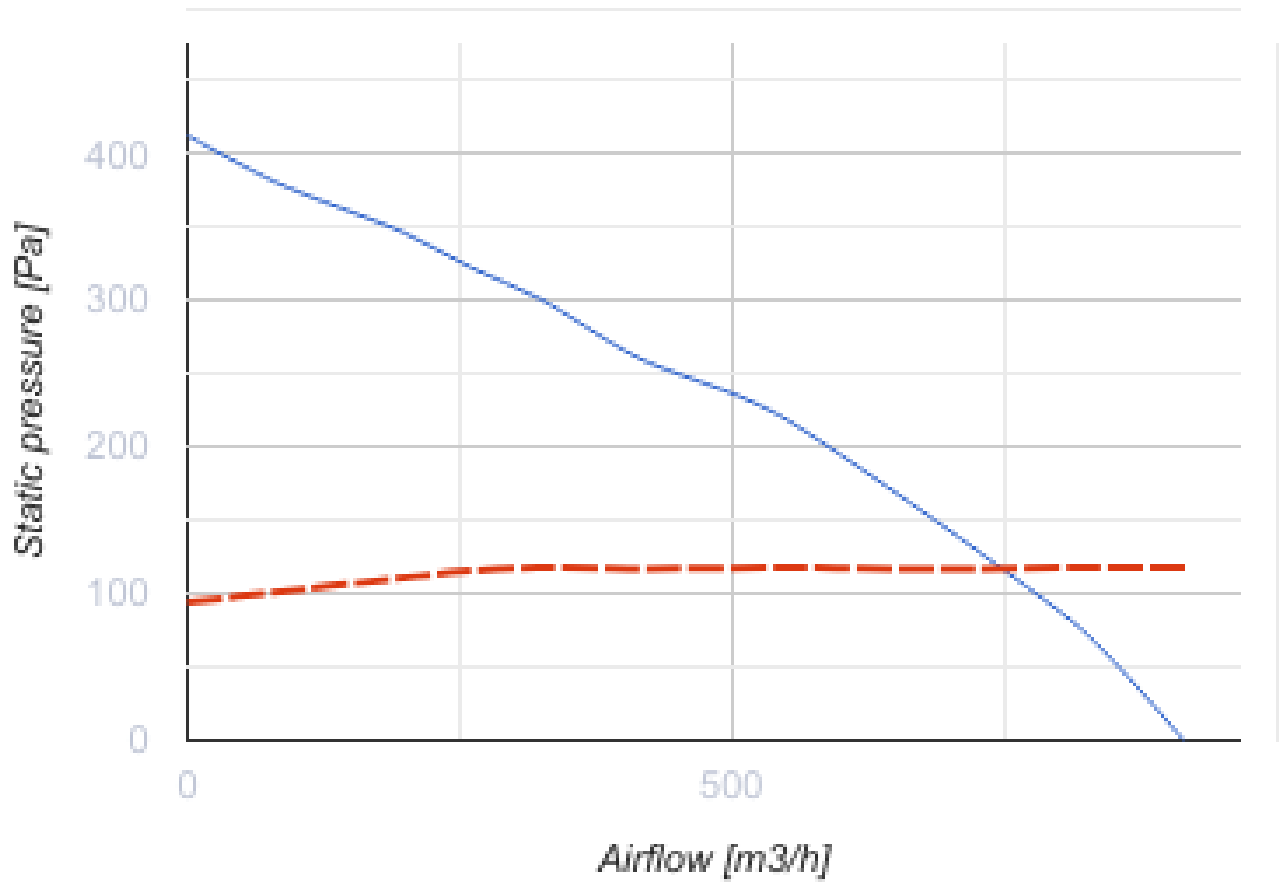

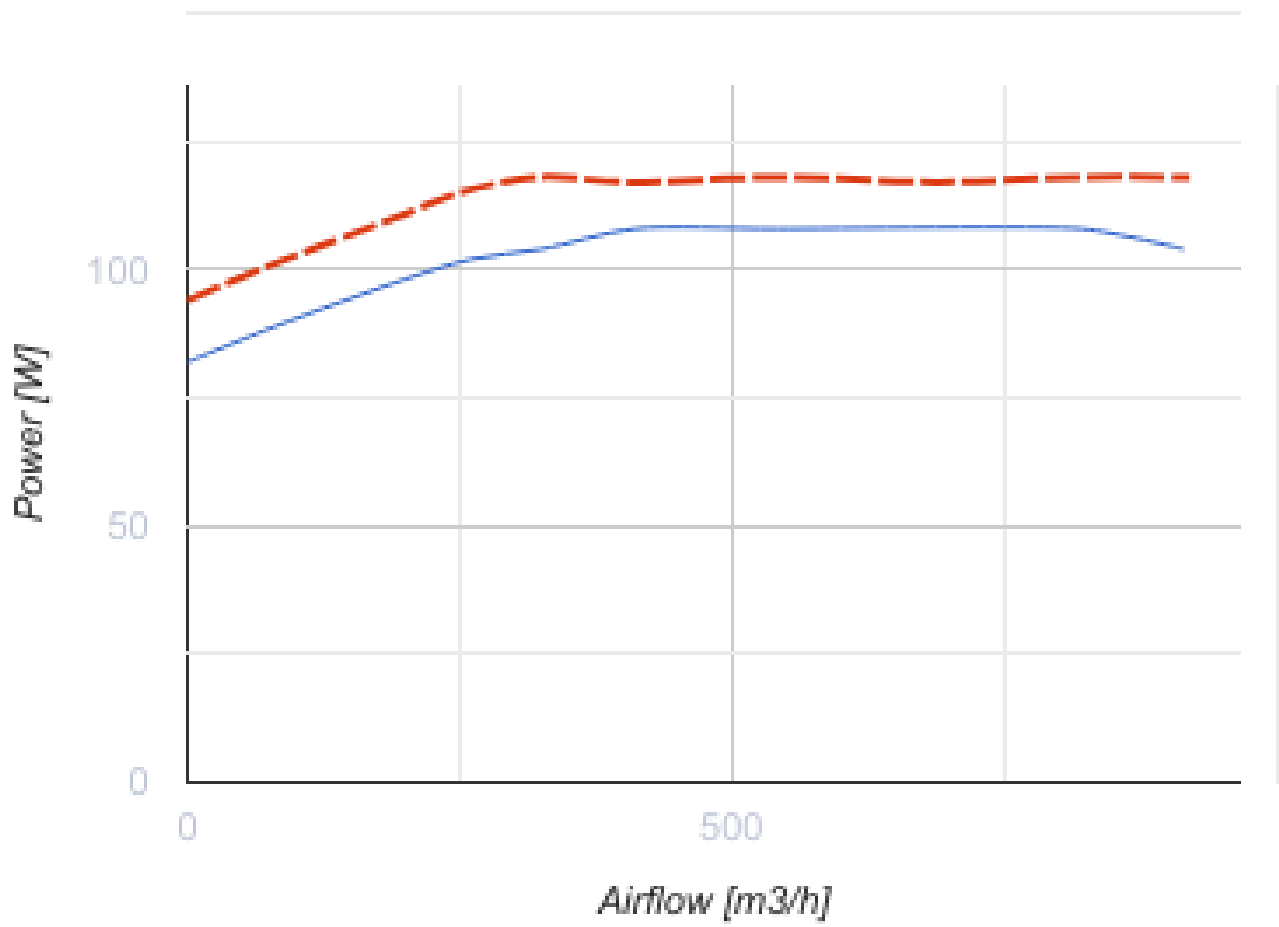

Dimensions

H	ØD	ØD1	L	L1
186	503	210	330	245

