

Tower-H 630 6D

Roof centrifugal fans



- Maximum airflow: 12640
- Sound pressure level LpA at 3 m: 64
- Motor type: AC
- Impeller type: Centrifugal backward curved blades
- Casing material: Coated steel

	Unit of measurement	Tower-H 630 6D
Speed	-	1
Minimum supply voltage	V	400
Maximum supply voltage	V	400
Power supply frequency	Hz	50
Rated power	W	1110
Unit current	A	2.42
Maximum airflow	m ³ /h	12640
Sound pressure level LpA at 3 m	dB(A)	64
Weight	kg	96.3
Transported air temperature (max)	°C	50
Transported air temperature (min)	°C	-25
Ingress protection rating	-	IPX4
Ingress protection rating of the drive	-	IP54

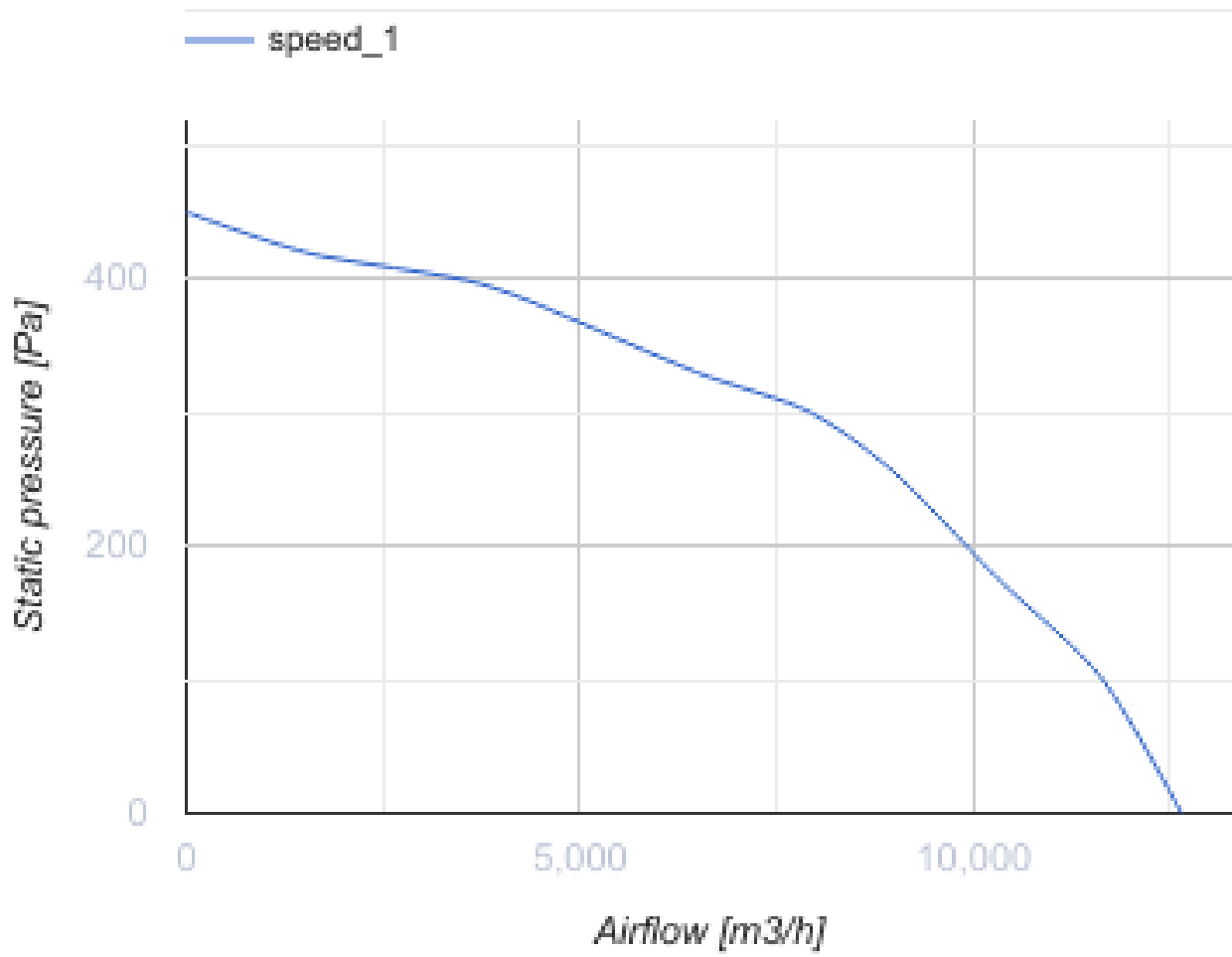

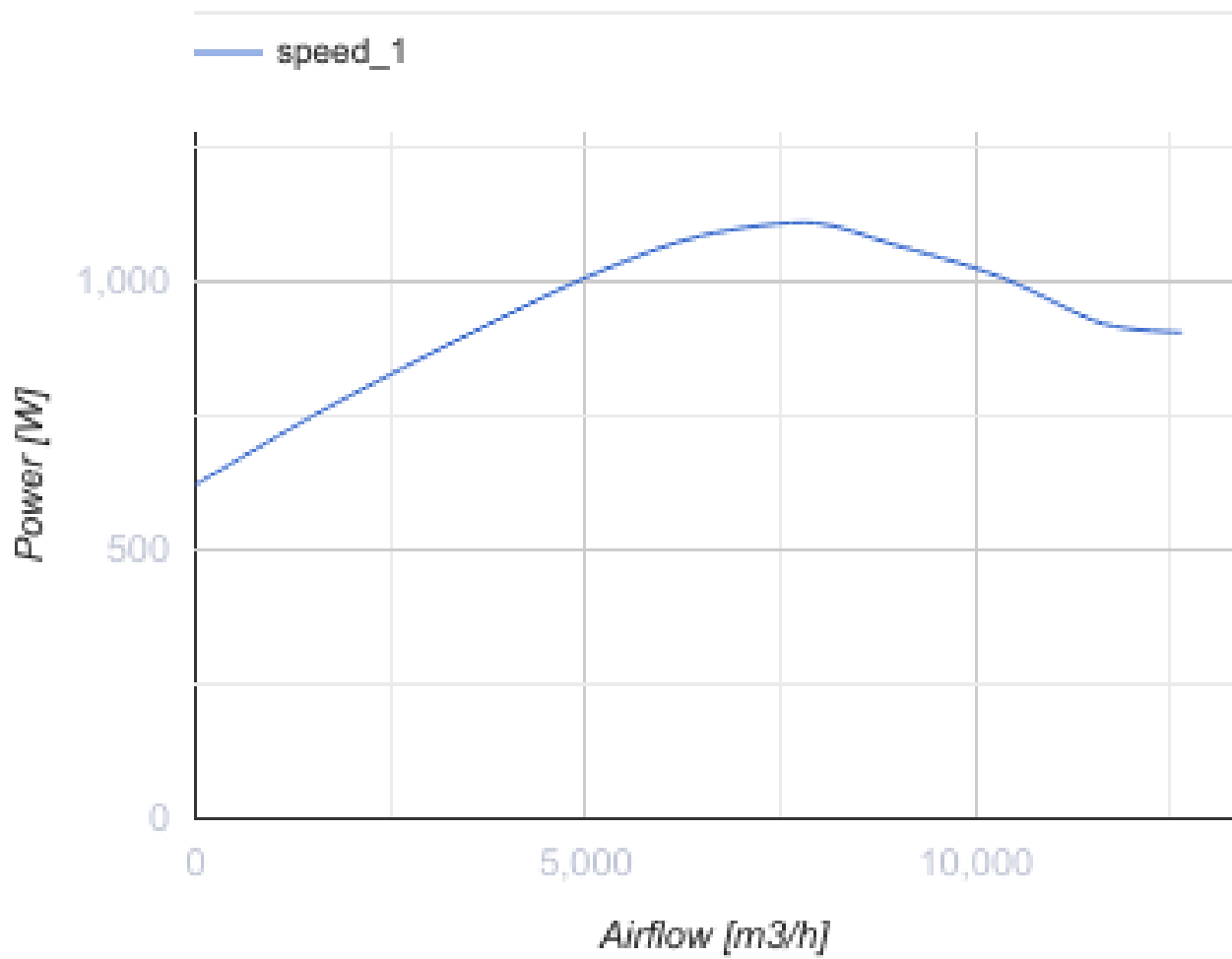

Dimensions

ØD	H	H1	L	L1
600	520	560	1000	990

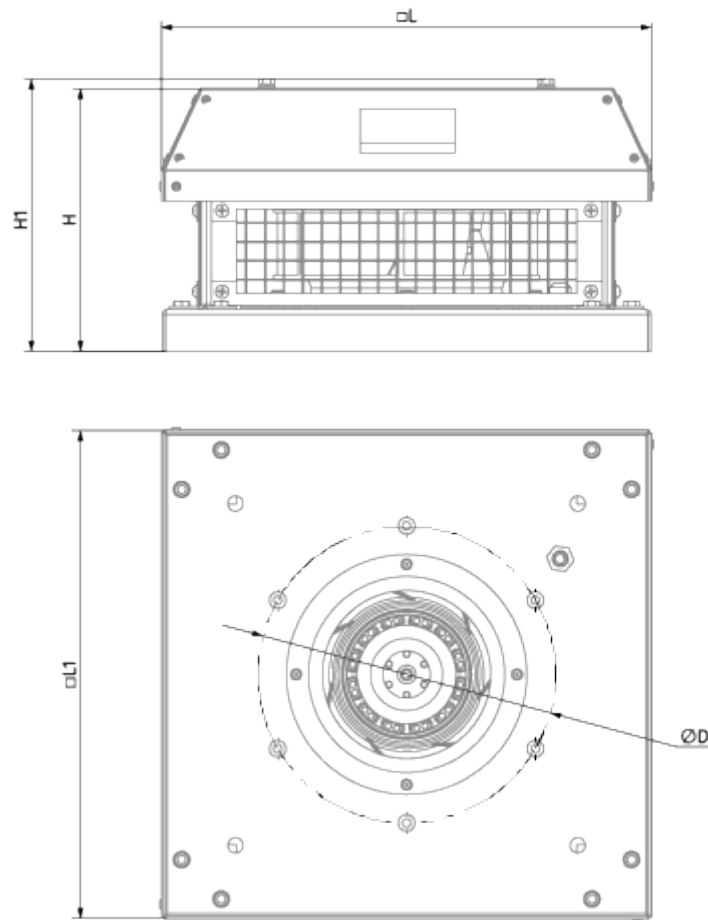

Accessories

Thyristor speed controllers

Name	Photo	Description
CDT E1.8		Thyristor speed controller