

Tower-H 225 4E

Roof centrifugal fans



- Maximum airflow: 738
- Sound pressure level LpA at 3 m: 45
- Motor type: AC
- Impeller type: Centrifugal backward curved blades
- Casing material: Coated steel

	Unit of measurement	Tower-H 225 4E
Speed	-	1
Minimum supply voltage	V	230
Maximum supply voltage	V	230
Power supply frequency	Hz	50
Rated power	W	49
Unit current	A	0.22
Maximum airflow	m ³ /h	738
Sound pressure level LpA at 3 m	dB(A)	45
Weight	kg	8.8
Transported air temperature (max)	°C	50
Transported air temperature (min)	°C	-25
Ingress protection rating	-	IPX4
Ingress protection rating of the drive	-	IP44

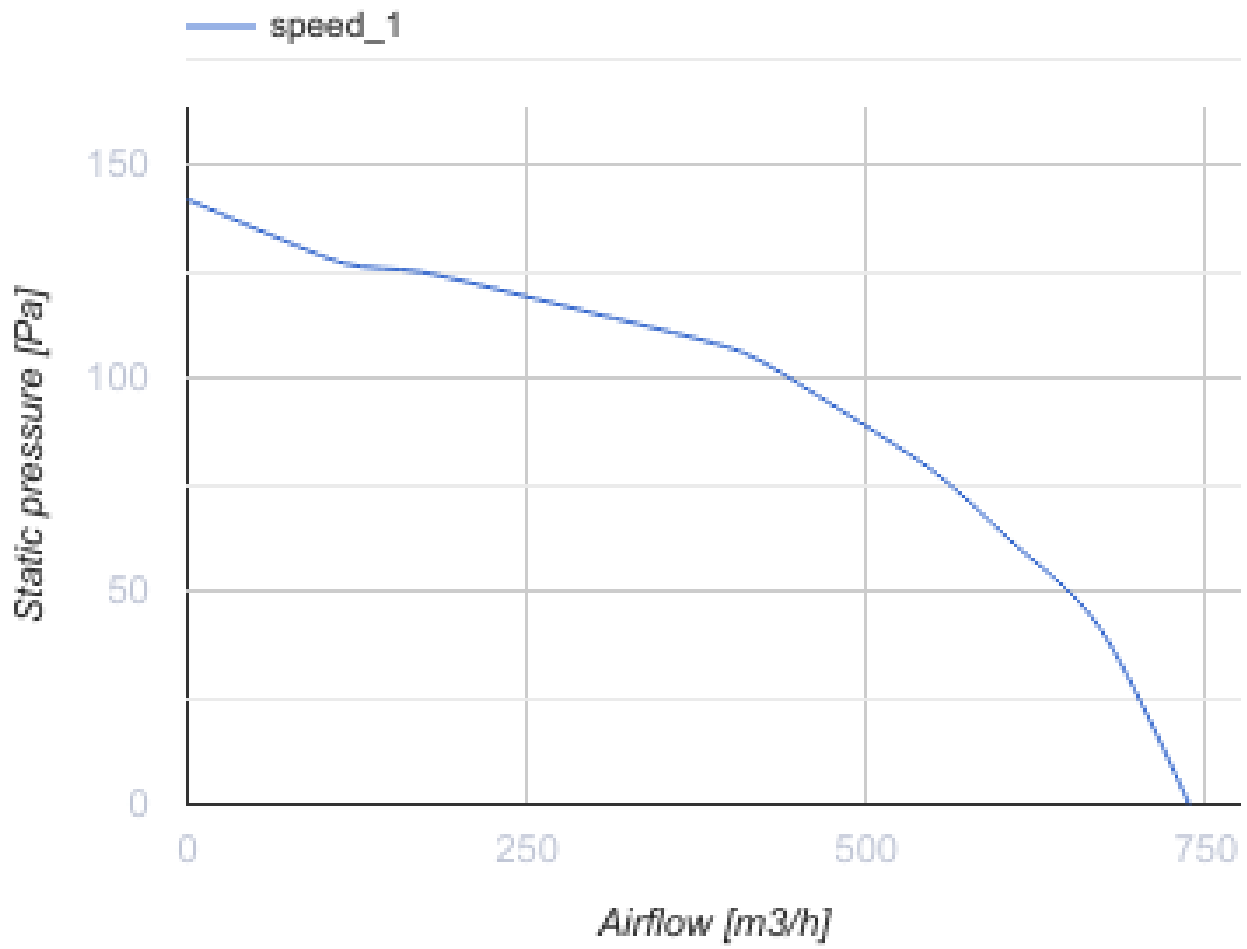

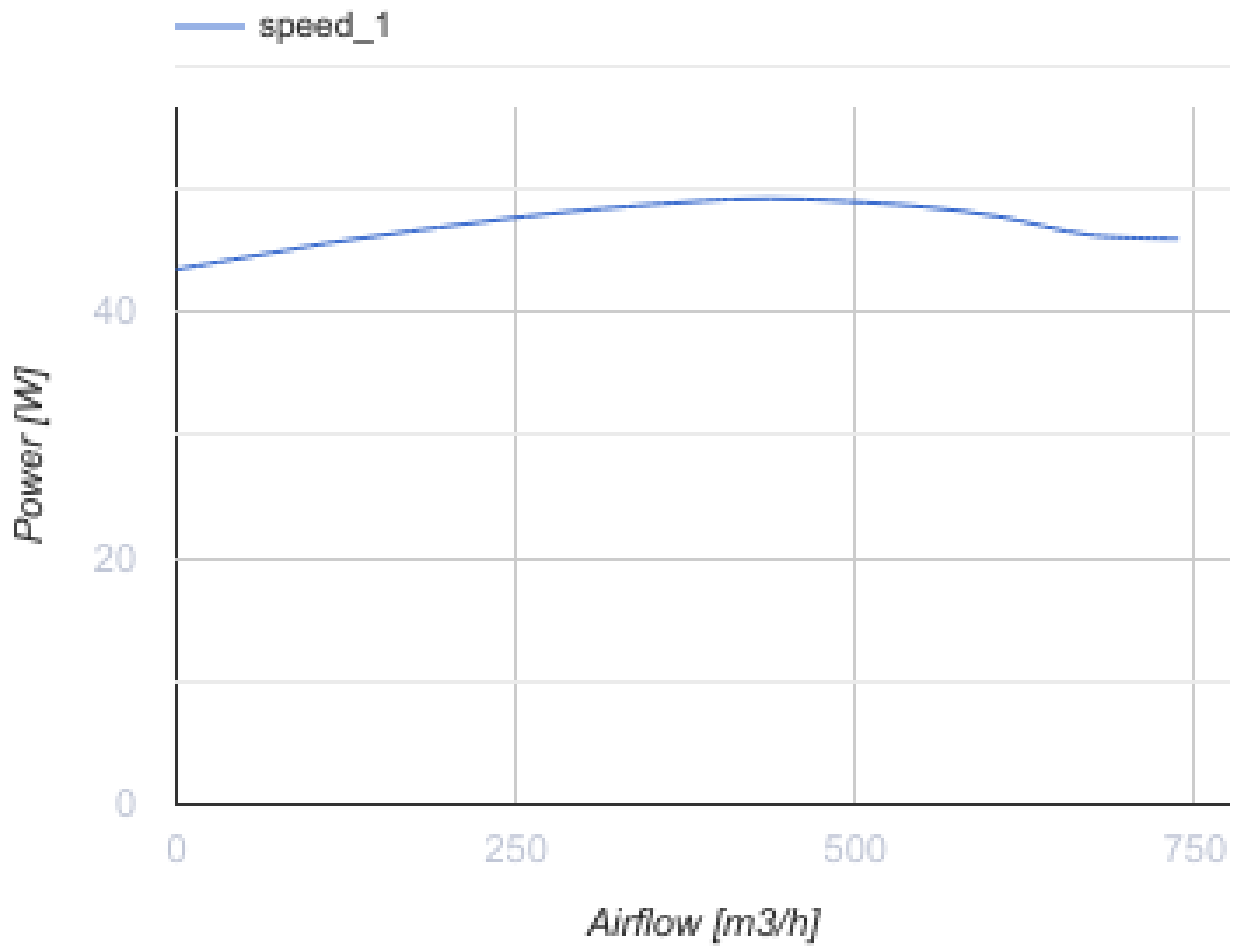

Dimensions

ØD	H	H1	L	L1
210	233	240	351	350

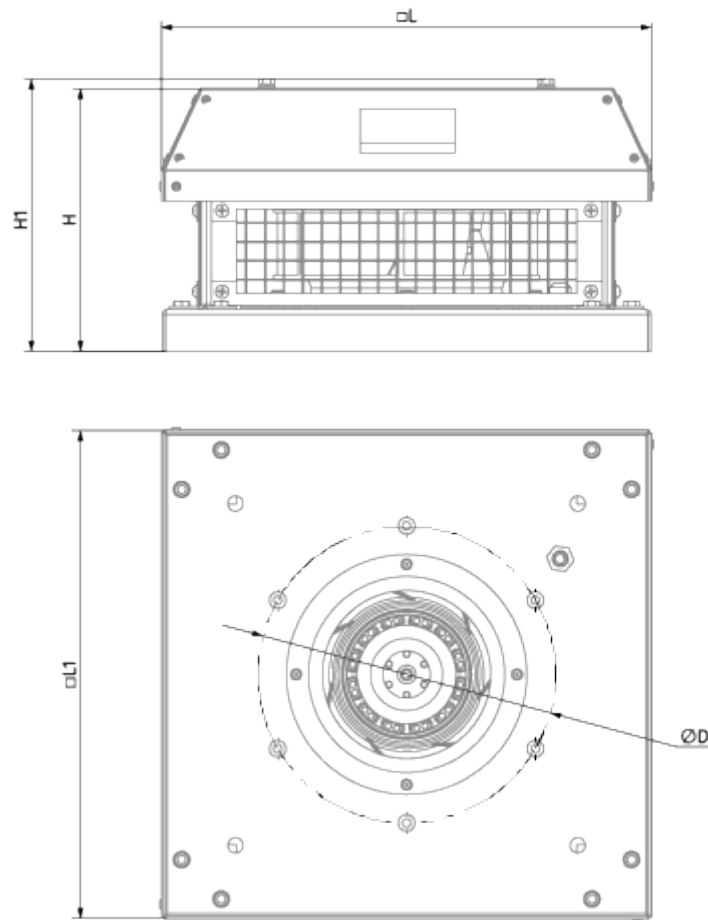

Accessories

Thyristor speed controllers

Name	Photo	Description
CDT E1.8		Thyristor speed controller