



# Reneo SE 550 L S21

Heat and energy recovery air handling units

- Power of electrical preheater: 1400
- Maximum airflow: 660
- Sound pressure level LpA at 3 m: 57
- Heat exchanger type: Counter flow
- Extract filter: Coarse > 60 %
- Supply filter: Coarse > 60 % (option: ePM1 60 %)
- Sound insulation
- Motor type: EC
- Bypass: Auto
- Reheater: Optional
- Preheater: Built-in
- BMS protocol: ModBus
- Control: Smartphone
- Casing material: EPP
- Humidity sensor: Optional
- CO2 sensor: Optional
- VOC sensor: Optional
- PM2.5 sensor: Optional

	Unit of measurement	Reneo SE 550 L S21
Connected air duct size	mm	200
Phases	-	1
Minimum supply voltage	V	230
Maximum supply voltage	V	230
Power supply frequency	Hz	50/60
Rated power	W	347
Power of electrical preheater	W	1400
Unit current	A	8.61
Maximum airflow	m <sup>3</sup> /h	660
Sound pressure level LpA at 3 m	dB(A)	57
Heat recovery efficiency, max	%	91
Heat exchanger type	-	Counter flow
Heat exchanger material	-	Polystyrene
Weight	kg	28
Extract filter	-	Coarse > 60 %
Supply filter	-	Coarse > 60 % (option: ePM1 60 %)
Transported air temperature (max)	°C	40
Transported air temperature (min)	°C	-25
Ambient air temperature min	°C	1

Ambient air temperature max	°C	40
Ambient air humidity max	%	60
Ingress protection rating	-	IP22
Ingress protection rating of the drive	-	IP44

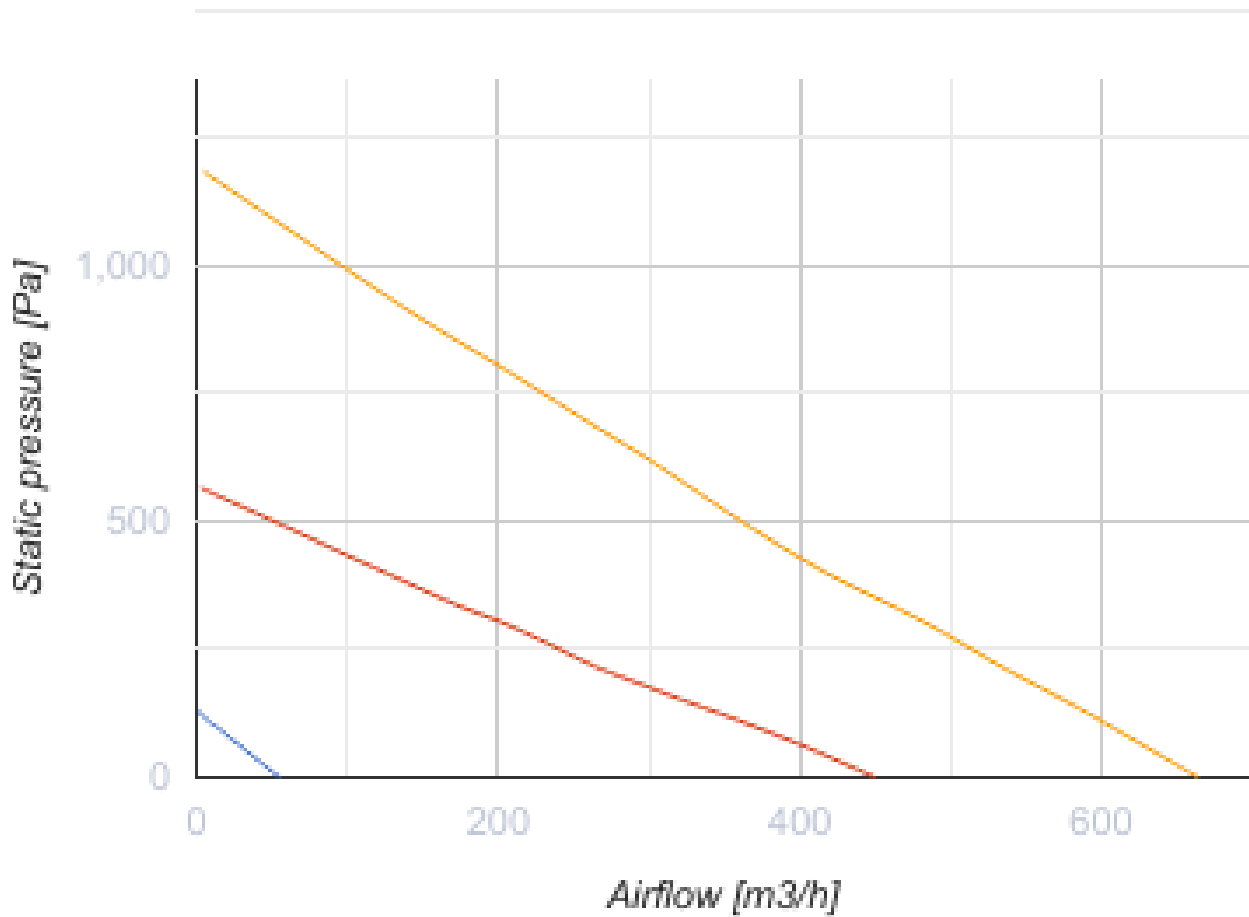

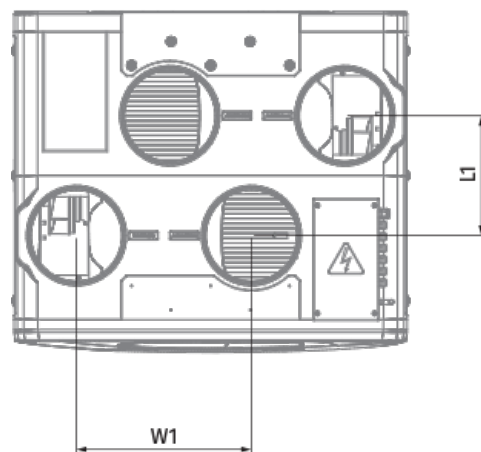
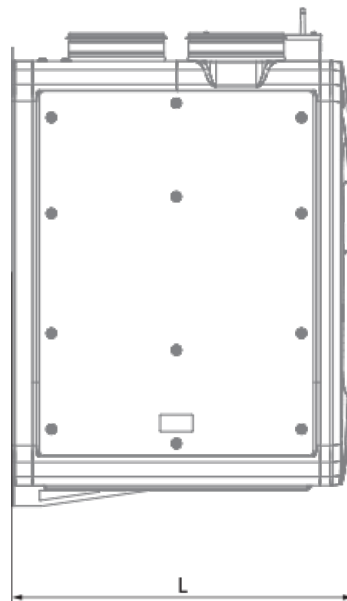
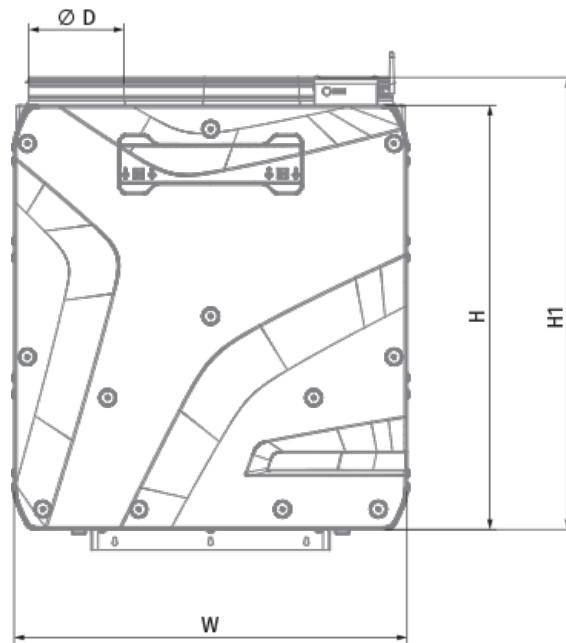

## Dimensions

Ø D	H	H1	L	L1	W	W1
200	885	943	711	250	820	365





## Accessories



### Other accessories

Name	Photo	Description
FP 596x164x60 Coarse 90% G4		G4 panel filter
FP 596x164x60 ePM1 60% F7		F7 panel filter

### Other accessories



Name	Photo	Description
<a href="#">S25</a>		LCD control panel
<a href="#">S22</a>		Control panels
<a href="#">S22 Wi-Fi</a>		Control panels

### Other accessories

Name	Photo	Description
<a href="#">FS2</a>		Humidity sensor
<a href="#">CD-3</a>		
<a href="#">CD-1</a>		CO2 sensors
<a href="#">CD-2</a>		CO2 sensors

### Other accessories



Name	Photo	Description
------	-------	-------------

<a href="#">ENH 200-1.2-1 S21 V.2</a>		Duct heater for supply air reheating
<a href="#">ENH 200-1.7-1 S21 V.2</a>		Duct heater for supply air reheating
<a href="#">ENH 200-2.0-1 S21 V.2</a>		Duct heater for supply air reheating

#### Other accessories

Name	Photo	Description
<a href="#">SFK 20x32</a>		Hydraulic syphon for condensate drainage

#### Other accessories

Name	Photo	Description
<a href="#">SD 200/600</a>		Silencers for round ducts
<a href="#">SD 200/900</a>		Silencers for round ducts
<a href="#">SD 200/1200</a>		Silencers for round ducts

#### Other accessories

Name	Photo	Description
<a href="#">VKA 200</a>		Air dampers for round ducts