

Reneo SE 270-E L S21

Heat and energy recovery air handling units



- Power of electrical preheater: 1400
- Maximum airflow: 304
- Sound pressure level LpA at 3 m: 37
- Heat exchanger type: Counter flow
- Extract filter: G4 / Coarse > 60%
- Supply filter: G4 / Coarse > 60% (option: F7 / ePM1 60%)
- Sound insulation
- Motor type: EC
- Enthalpy heat exchanger
- Bypass: Auto
- Reheater: Optional
- Preheater: Built-in
- BMS protocol: ModBus
- Control: Smartphone
- Casing material: EPP
- Humidity sensor: Optional
- CO2 sensor: Optional
- VOC sensor: Optional
- PM2.5 sensor: Optional

	Unit of measurement	Reneo SE 270-E L S21
Connected air duct size	mm	125
Phases	-	1
Minimum supply voltage	V	230
Maximum supply voltage	V	230
Power supply frequency	Hz	50/60
Rated power	W	176
Power of electrical preheater	W	1400
Unit current	A	7.55
Maximum airflow	m ³ /h	304
Sound pressure level LpA at 3 m	dB(A)	37
Heat recovery efficiency, max	%	84
Heat exchanger type	-	Counter flow
Heat exchanger material	-	Enthalpy
Weight	kg	22
Extract filter	-	G4 / Coarse > 60%
Supply filter	-	G4 / Coarse > 60% (option: F7 / ePM1 60%)
Transported air temperature (max)	°C	40
Transported air temperature (min)	°C	-25

Ambient air temperature min	°C	1
Ambient air temperature max	°C	40
Ambient air humidity max	%	60
Ingress protection rating	-	IP22
Ingress protection rating of the drive	-	IP44

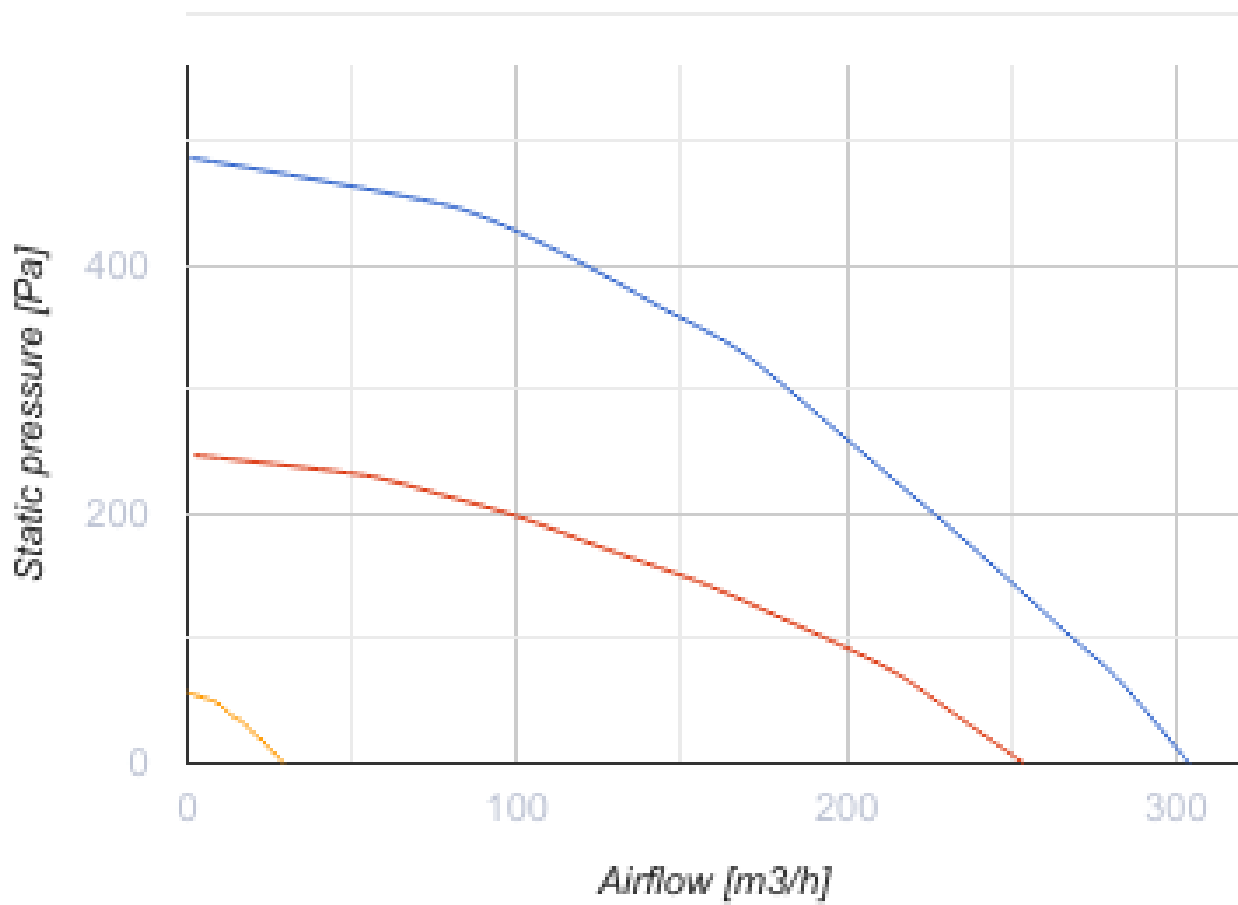

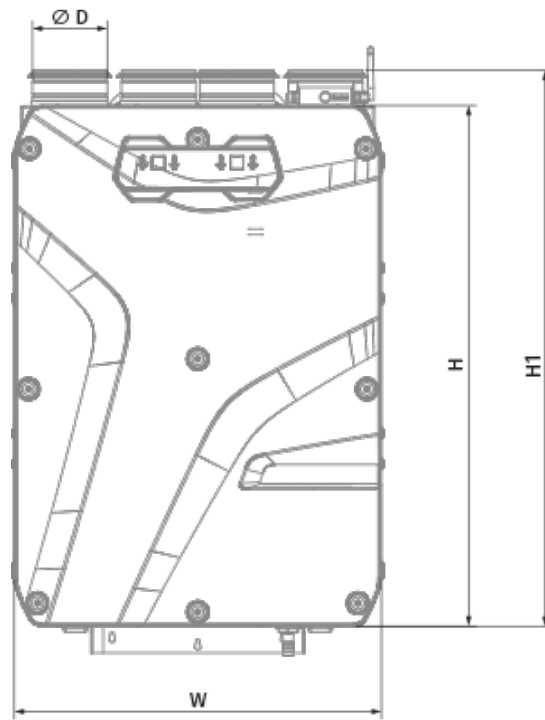

Dimensions

Ø D	H	H1	L	L1	W	W1
125	852	909	419	160	600	273





Accessories

Other accessories

Name	Photo	Description
FP 356x100x48 Coarse 90% G4		G4 panel filter
FP 356x100x48 ePM1 60% F7		F7 panel filter



Control Panels

Name	Photo	Description
S22		Control panels
S22 Wi-Fi		Control panels
S25		LCD control panel

Humidity sensors



Name	Photo	Description
FS2		Humidity sensor

CO2 sensors



Name	Photo	Description
CD-1		CO2 sensors
CD-2		CO2 sensors

CD-3

Electrical heaters

Name	Photo	Description
ENH 125-0.6-1 S21 V.2		Duct heater for supply air reheating
ENH 125-0.8-1 S21 V.2		Duct heater for supply air reheating
ENH 125-1.2-1 S21 V.2		Duct heater for supply air reheating

For round ducts

Name	Photo	Description
SD 125/600		Silencers for round ducts
SD 125/900		Silencers for round ducts
SD 125/1200		Silencers for round ducts

For round ducts

Name	Photo	Description
VKA 125		Air dampers for round ducts