



Reneo S 210-E L S14

Heat and energy recovery air handling units

- Maximum airflow: 255
- Sound pressure level LpA at 3 m: 34
- Heat exchanger type: Counter flow
- Extract filter: G4 / Coarse > 60%
- Supply filter: G4 / Coarse > 60% (option: F7 / ePM1 60%)
- Sound insulation
- Motor type: EC
- Enthalpy heat exchanger
- Bypass: Manual
- Control: Wired control panel
- Casing material: EPP
- Humidity sensor: Optional
- CO2 sensor: Optional

	Unit of measurement	Reneo S 210-E L S14
Connected air duct size	mm	125
Phases	-	1
Minimum supply voltage	V	230
Maximum supply voltage	V	230
Power supply frequency	Hz	50/60
Rated power	W	114
Unit current	A	0.92
Maximum airflow	m ³ /h	255
Sound pressure level LpA at 3 m	dB(A)	34
Heat recovery efficiency, max	%	83
Heat exchanger type	-	Counter flow
Heat exchanger material	-	Enthalpy
Weight	kg	20
Extract filter	-	G4 / Coarse > 60%
Supply filter	-	G4 / Coarse > 60% (option: F7 / ePM1 60%)
Transported air temperature (max)	°C	40
Transported air temperature (min)	°C	-25
Ambient air temperature min	°C	1
Ambient air temperature max	°C	40
Ambient air humidity max	%	60
Ingress protection rating	-	IP22

Ingress protection rating of the drive	-	IP44
----------------------------------------	---	------

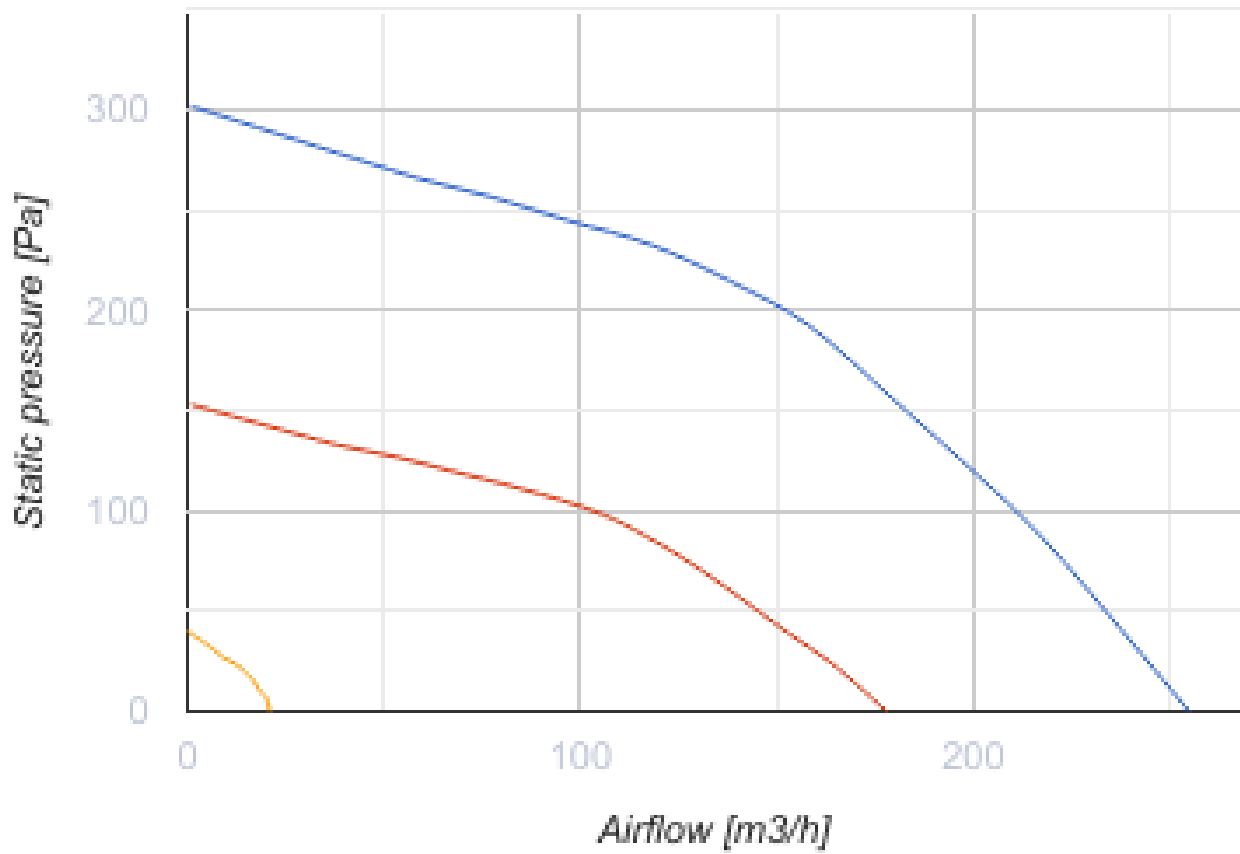

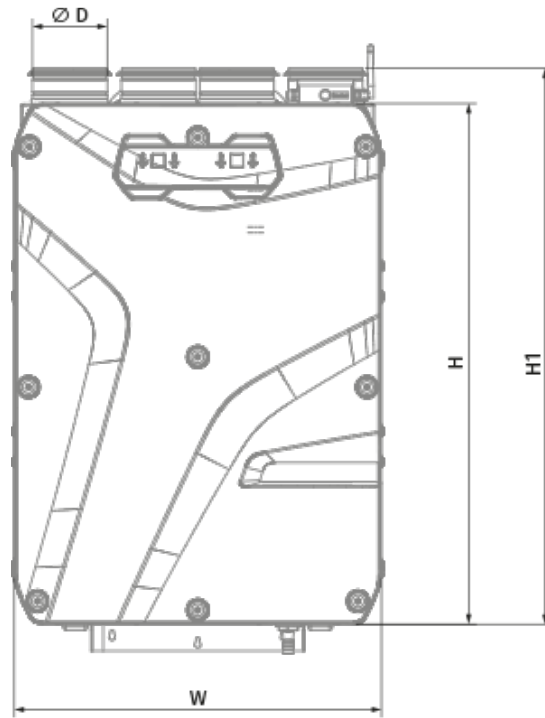

Dimensions

Ø D	H	H1	L	L1	W	W1
125	852	909	419	160	600	273





Accessories



Other accessories

Name	Photo	Description
FP 356x100x48 Coarse 90% G4		G4 panel filter
FP 356x100x48 ePM1 60% F7		F7 panel filter

Other accessories

Name	Photo	Description
FS2		Humidity sensor
CD-1		CO2 sensors
CD-2		CO2 sensors
CD-3		

Other accessories

Name	Photo	Description
SD 125/600		Silencers for round ducts
SD 125/900		Silencers for round ducts
SD 125/1200		Silencers for round ducts

Other accessories

Name	Photo	Description
------	-------	-------------

[VKA 125](#)



Air dampers for round ducts