

Reneo-Fit D 200 S21

Heat and energy recovery air handling units



- Maximum airflow: 279
- Sound pressure level LpA at 3 m: 33
- Heat exchanger type: Counter flow
- Extract filter: G4 / Coarse > 60%
- Supply filter: G4 / Coarse > 60% (option F7 / ePM1 60%)
- Sound insulation
- Motor type: EC
- Bypass: Auto
- Reheater: Optional
- Preheater: Optional
- BMS protocol: ModBus
- Control: Smartphone
- Casing material: EPP
- Humidity sensor: Optional
- CO2 sensor: Optional
- VOC sensor: Optional
- PM2.5 sensor: Optional

	Unit of measurement	Reneo-Fit D 200 S21
Connected air duct size	mm	160/125
Phases	-	1
Minimum supply voltage	V	230
Maximum supply voltage	V	230
Power supply frequency	Hz	50/60
Rated power	W	135
Unit current	A	1.02
Maximum airflow	m ³ /h	279
Sound pressure level LpA at 3 m	dB(A)	33
Heat recovery efficiency, max	%	89
Heat exchanger type	-	Counter flow
Heat exchanger material	-	Polystyrene
Weight	kg	18
Extract filter	-	G4 / Coarse > 60%
Supply filter	-	G4 / Coarse > 60% (option F7 / ePM1 60%)
Transported air temperature (max)	°C	45
Ambient air temperature min	°C	1
Ambient air temperature max	°C	40
Ambient air humidity max	%	60

Ingress protection rating	-	IP22
Ingress protection rating of the drive	-	IP44

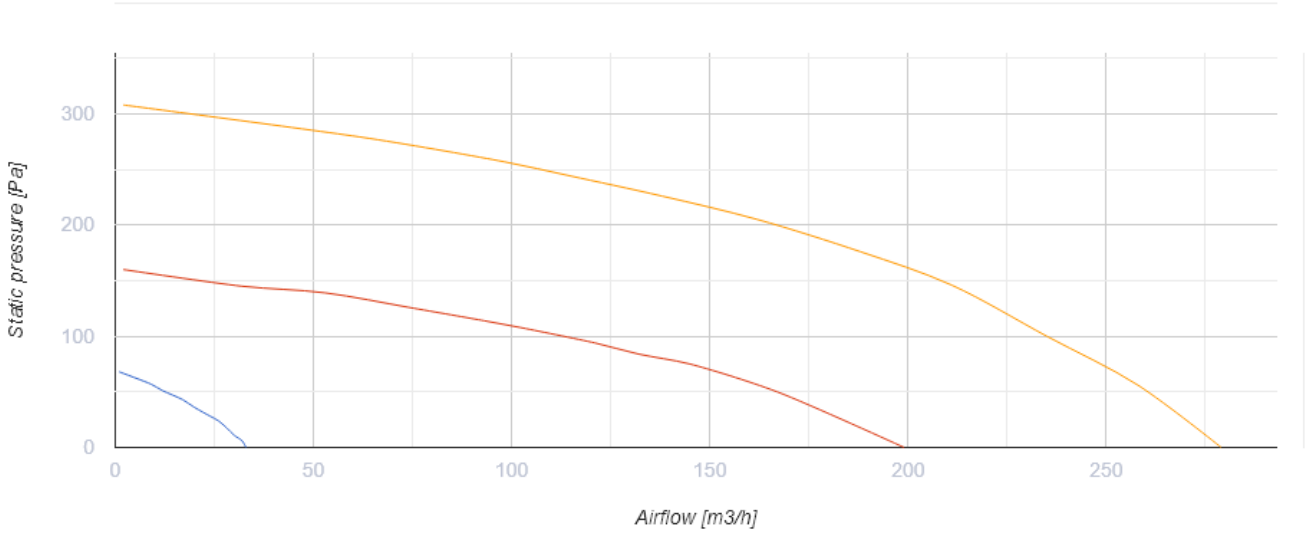

Dimensions

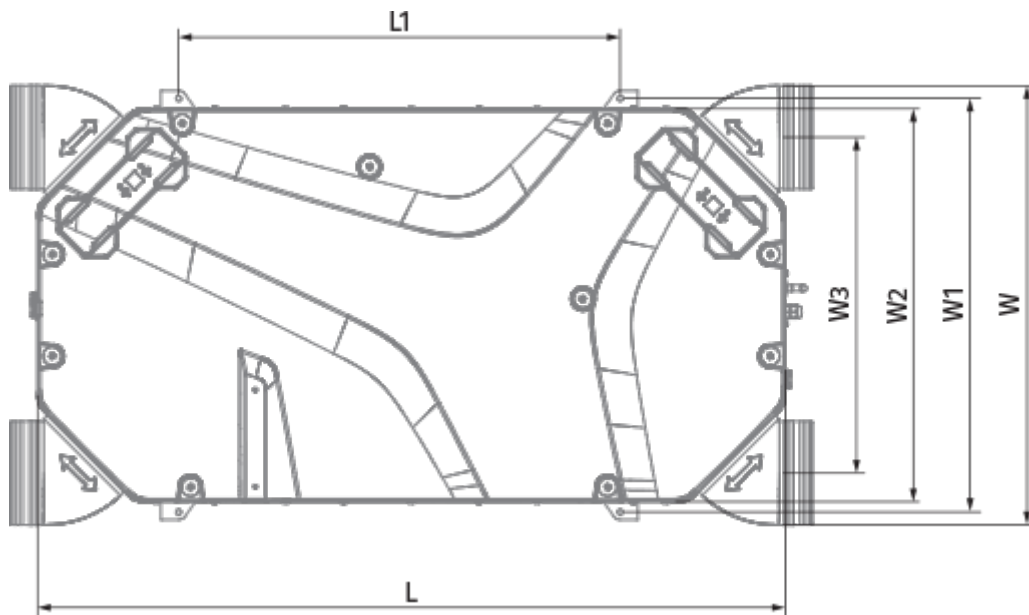

Ø D	Ø D1	H	L	L1	W	W1	W2	W3
160	125	242	1160	685	683	642	610	521

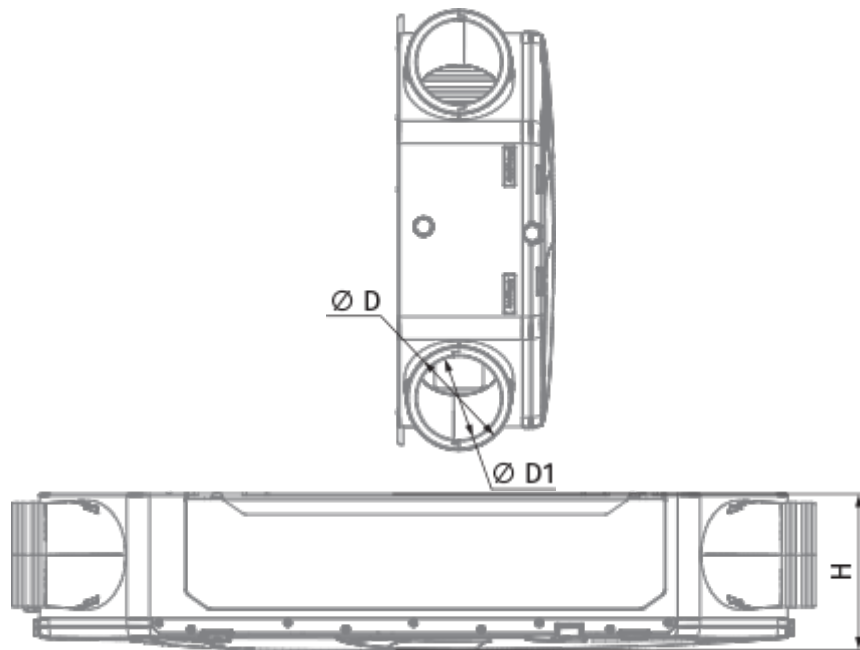





Accessories

Other accessories

Name	Photo	Description
FP 200x165x48 Coarse 90% G4		G4 panel filter
FP 200x165x48 ePM1 60% F7		F7 panel filter

Control Panels



Name	Photo	Description
S25		LCD control panel
S22		Control panels

S22 Wi-Fi		Control panels
---------------------------	---	----------------







Humidity sensors

Name	Photo	Description
FS2		Humidity sensor

CO2 sensors

Name	Photo	Description
CD-3		
CD-1		CO2 sensors
CD-2		CO2 sensors

Electrical heaters



Name	Photo	Description
EVH 160-0.8-1 S21 V.2		Electric duct preheater for heat exchanger freeze protection
EVH 160-1.2-1 S21 V.2		Electric duct preheater for heat exchanger freeze protection
EVH 160-1.7-1 S21 V.2		Electric duct preheater for heat exchanger freeze protection
EVH 160-2.0-1 S21 V.2		Electric duct preheater for heat exchanger freeze protection
ENH 160-0.8-1 S21 V.2		Duct heater for supply air reheating
ENH 160-1.2-1 S21 V.2		Duct heater for supply air reheating
ENH 160-1.7-1 S21 V.2		Duct heater for supply air reheating

ENH 160-2.0-1 S21 V.2		Duct heater for supply air reheating
---------------------------------------	---	--------------------------------------

Condensation drainage

Name	Photo	Description
SFK 20x32		Hydraulic syphon for condensate drainage

For round ducts

Name	Photo	Description
SD 160/600		Silencers for round ducts
SD 160/900		Silencers for round ducts
SD 160/1200		Silencers for round ducts

For round ducts

Name	Photo	Description
VKA 160		Air dampers for round ducts