

Reneo-Fit D 200 S14

Heat and energy recovery air handling units



- Maximum airflow: 309
- Sound pressure level LpA at 3 m: 34
- Heat exchanger type: Counter flow
- Extract filter: Coarse > 60 %
- Supply filter: Coarse > 60 % (option: ePM1 60 %), Coarse > 60 % (опция: ePM1 60 %)
- Sound insulation
- Motor type: EC
- Bypass: Manual
- Control: Wired control panel
- Casing material: EPP
- Humidity sensor: Optional
- CO2 sensor: Optional

| | Unit of measurement | Reneo-Fit D 200 S14 |
|--|---------------------|---|
| Connected air duct size | mm | 125 / 160 |
| Phases | - | 1 |
| Minimum supply voltage | V | 230 |
| Maximum supply voltage | V | 230 |
| Power supply frequency | Hz | 50/60 |
| Rated power | W | 169 |
| Unit current | A | 1.28 |
| Maximum airflow | m ³ /h | 309 |
| Sound pressure level LpA at 3 m | dB(A) | 34 |
| Heat recovery efficiency, max | % | 87 |
| Heat exchanger type | - | Counter flow |
| Heat exchanger material | - | Polystyrene |
| Weight | kg | 12 |
| Extract filter | - | Coarse > 60 % |
| Supply filter | - | Coarse > 60 % (option: ePM1 60 %), Coarse > 60 % (опция: ePM1 60 %) |
| Transported air temperature (max) | °C | 45 |
| Ingress protection rating | - | IP22 |
| Ingress protection rating of the drive | - | IP44 |

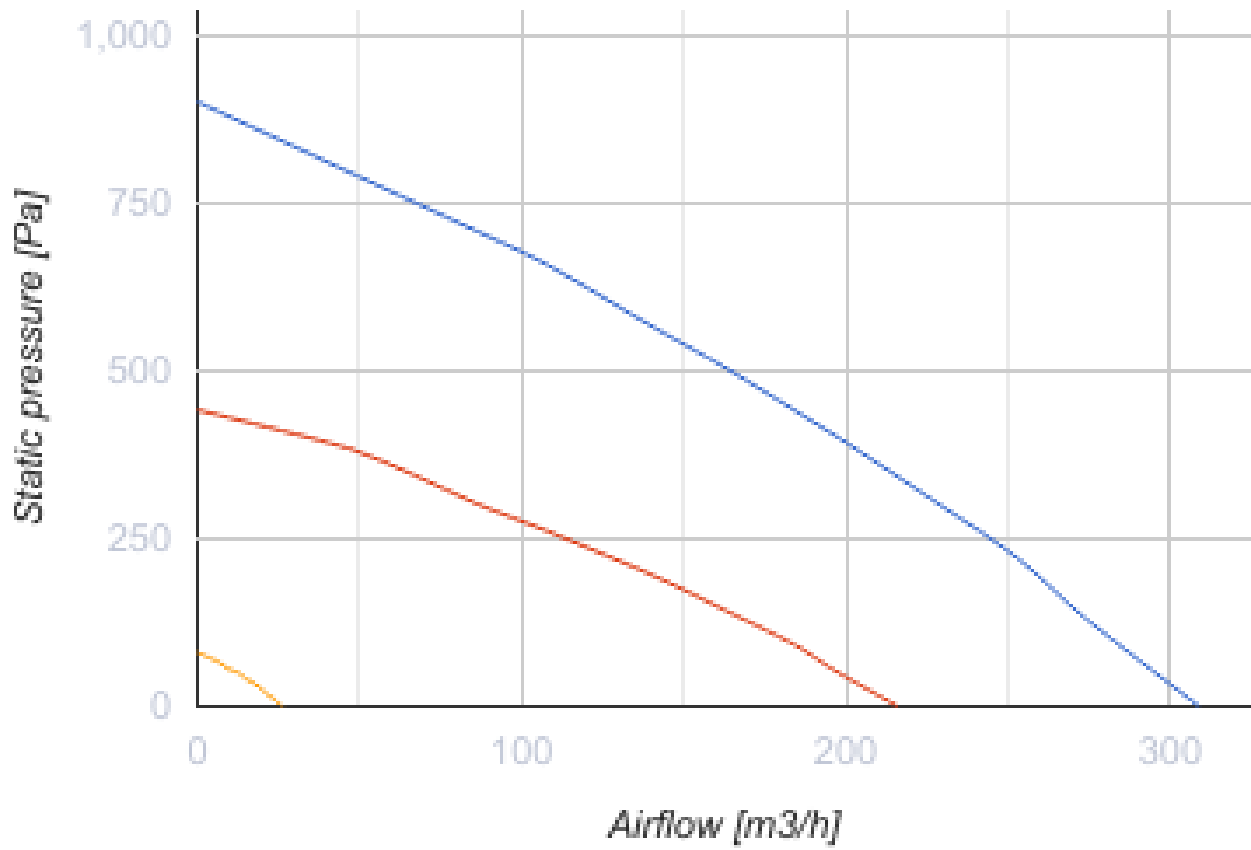

Dimensions

| Ø D | Ø D1 | H | L | L1 | W | W1 | W2 | W3 |
|-----|------|-----|------|-----|-----|-----|-----|-----|
| 160 | 125 | 241 | 1160 | 685 | 680 | 642 | 610 | 541 |

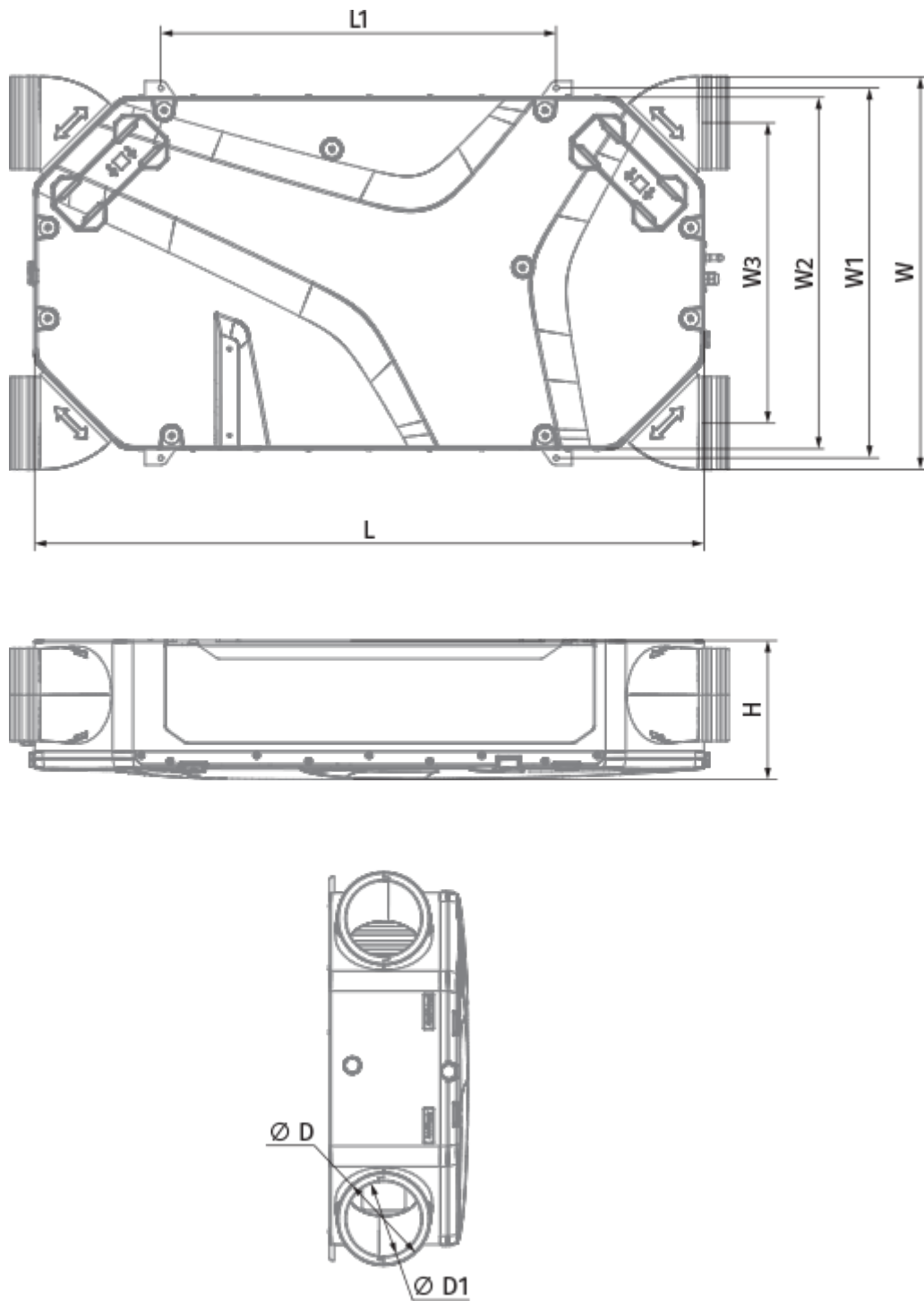

Accessories

Other accessories



| Name | Photo | Description |
|------|-------|-------------|
|------|-------|-------------|

| | | |
|-----------------------------|---|-----------------|
| FP 200x165x48 Coarse 90% G4 |  | G4 panel filter |
| FP 200x165x48 ePM1 60% F7 |  | F7 panel filter |

Humidity sensors

| Name | Photo | Description |
|---------------------|---|-----------------|
| FS2 |  | Humidity sensor |



CO2 sensors

| Name | Photo | Description |
|----------------------|---|-------------|
| CD-3 | | |
| CD-1 |  | CO2 sensors |
| CD-2 |  | CO2 sensors |

Condensation drainage

| Name | Photo | Description |
|---------------------------|---|--|
| SFK 20x32 |  | Hydraulic syphon for condensate drainage |

For round ducts

| Name | Photo | Description |
|----------------------------|---|---------------------------|
| SD 160/600 |  | Silencers for round ducts |
| SD 160/900 |  | Silencers for round ducts |

| | | |
|-----------------------------|---|---------------------------|
| SD 160/1200 |  | Silencers for round ducts |
|-----------------------------|---|---------------------------|

For round ducts

| Name | Photo | Description |
|-------------------------|---|-----------------------------|
| VKA 160 |  | Air dampers for round ducts |