

# Reneo-Fit D 150-E S14

Heat and energy recovery air handling units



- Maximum airflow: 229
- Sound pressure level LpA at 3 m: 27
- Heat exchanger type: Counter flow
- Extract filter: G4 / Coarse > 60%
- Supply filter: G4 / Coarse > 60% (option F7 / ePM1 60%)
- Sound insulation
- Motor type: EC
- Enthalpy heat exchanger
- Bypass: Manual
- Control: Wired control panel
- Casing material: EPP
- Humidity sensor: Optional
- CO2 sensor: Optional

	Unit of measurement	Reneo-Fit D 150-E S14
Connected air duct size	mm	160/125
Phases	-	1
Minimum supply voltage	V	230
Maximum supply voltage	V	230
Power supply frequency	Hz	50/60
Rated power	W	72
Unit current	A	0.63
Maximum airflow	m <sup>3</sup> /h	229
Sound pressure level LpA at 3 m	dB(A)	27
Heat recovery efficiency, max	%	85
Heat exchanger type	-	Counter flow
Heat exchanger material	-	Enthalpy
Weight	kg	19.5
Extract filter	-	G4 / Coarse > 60%
Supply filter	-	G4 / Coarse > 60% (option F7 / ePM1 60%)
Transported air temperature (max)	°C	45
Ambient air temperature min	°C	1
Ambient air temperature max	°C	40
Ambient air humidity max	%	60
Ingress protection rating	-	IP22

Ingress protection rating of the drive	-	IP44
--	---	------

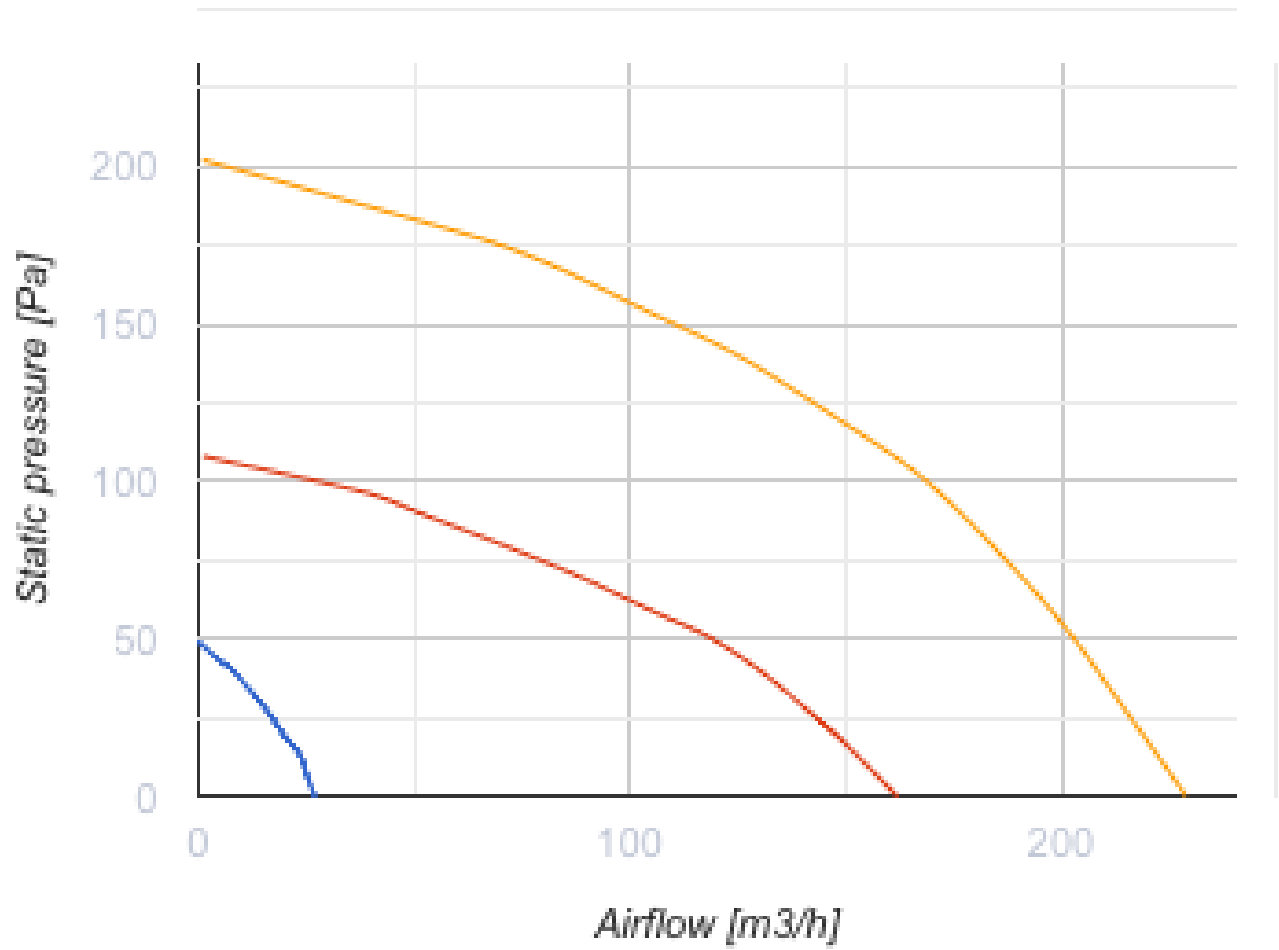

### Dimensions

Ø D	Ø D1	H	L	L1	W	W1	W2	W3
160	125	242	1160	685	683	642	610	521



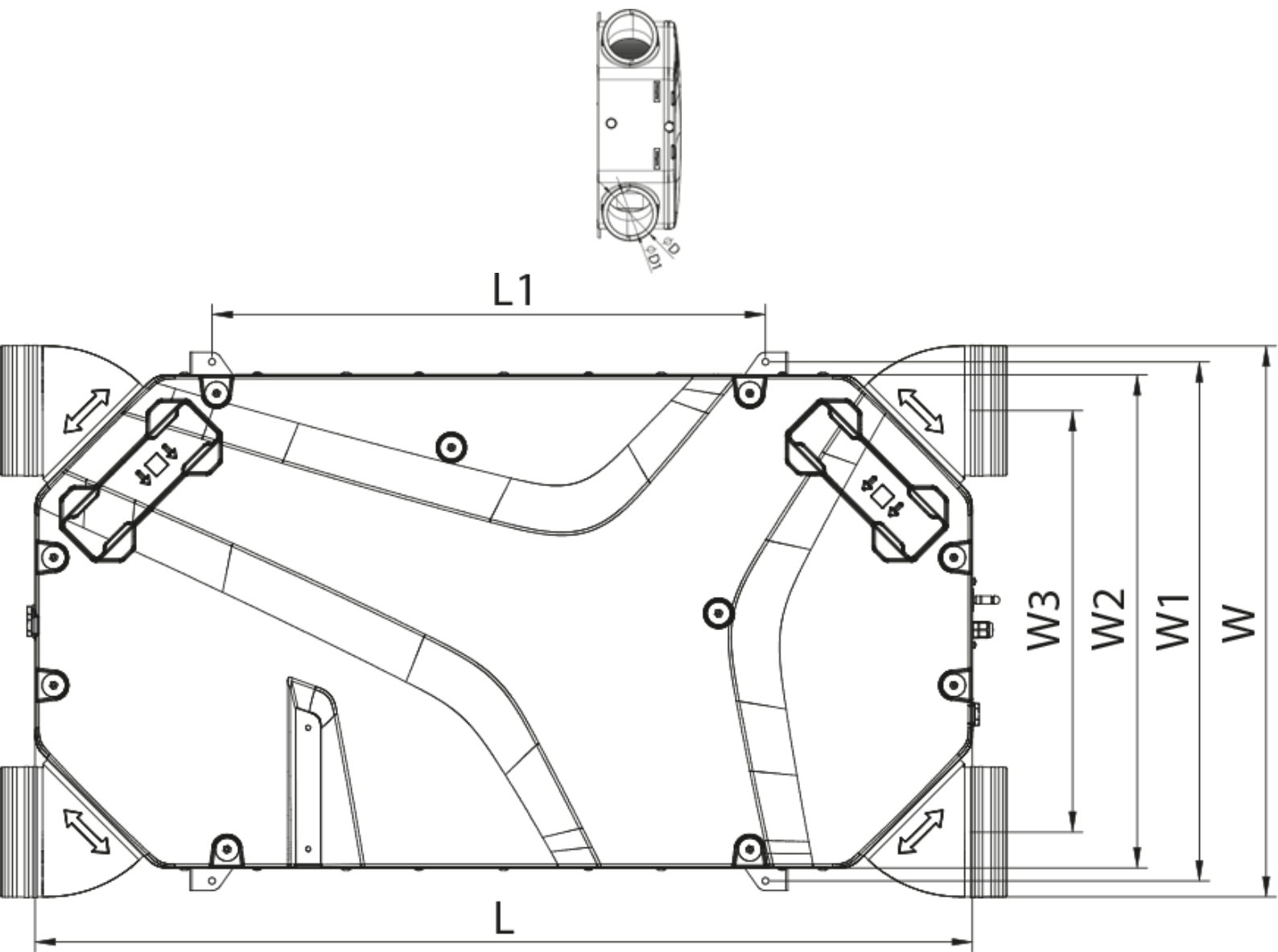





## Accessories

### Other accessories



Name	Photo	Description
FP 200x165x48 Coarse 90% G4		G4 panel filter

FP 200x165x48 ePM1 60% F7		F7 panel filter
---------------------------	---	-----------------

### Other accessories

Name	Photo	Description
<a href="#">FS2</a>		Humidity sensor
<a href="#">CD-1</a>		CO2 sensors
<a href="#">CD-2</a>		CO2 sensors

### Other accessories

Name	Photo	Description
<a href="#">SD 160/600</a>		Silencers for round ducts
<a href="#">SD 160/900</a>		Silencers for round ducts
<a href="#">SD 160/1200</a>		Silencers for round ducts

### Other accessories

Name	Photo	Description
<a href="#">VKA 160</a>		Air dampers for round ducts