

Reneo D 181-E S14

Heat and energy recovery air handling units

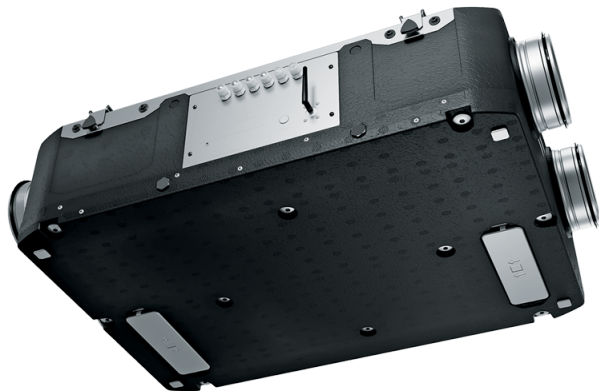

- Maximum airflow: 181
- Sound pressure level LpA at 3 m: 29
- Heat exchanger type: Counter flow
- Extract filter: Coarse > 60 %
- Supply filter: Coarse > 60 % (G4) (опция: ePM1 60 % (F7)), Coarse > 60 % (G4) (option: ePM1 60 % (F7))
- Sound insulation
- Motor type: EC
- Enthalpy heat exchanger
- Bypass: Manual
- Control: Wired control panel
- Casing material: EPP
- Humidity sensor: Optional
- CO2 sensor: Optional

	Unit of measurement	Reneo D 181-E S14
Connected air duct size	mm	160
Speed	-	0
Phases	-	1
Minimum supply voltage	V	230
Maximum supply voltage	V	230
Power supply frequency	Hz	50/60
Rated power	W	53
Power of electrical preheater	W	0
Unit current	A	0.49
Maximum airflow	m ³ /h	181
Sound pressure level LpA at 3 m	dB(A)	29
Heat recovery efficiency, max	%	84
Heat exchanger type	-	Counter flow
Heat exchanger material	-	Enthalpy
Weight	kg	15
Extract filter	-	Coarse > 60 %
Supply filter	-	Coarse > 60 % (G4) (опция: ePM1 60 % (F7)), Coarse > 60 % (G4) (option: ePM1 60 % (F7))
Transported air temperature (max)	°C	45
Ambient air temperature min	°C	1
Ambient air temperature max	°C	40

Ambient air humidity max	%	60
Ingress protection rating	-	IP22
Ingress protection rating of the drive	-	IP44

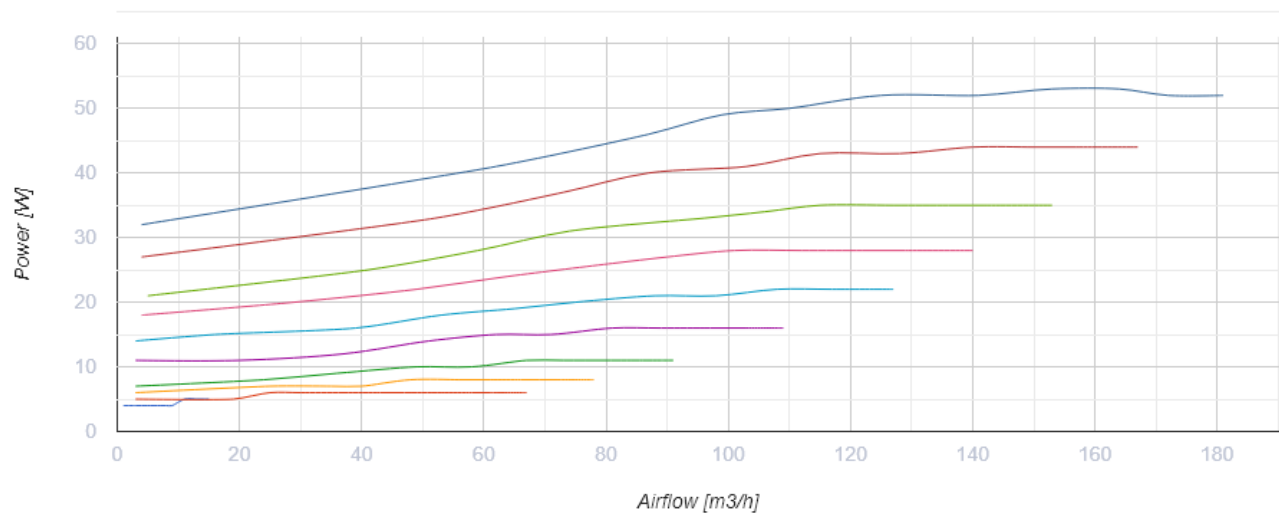
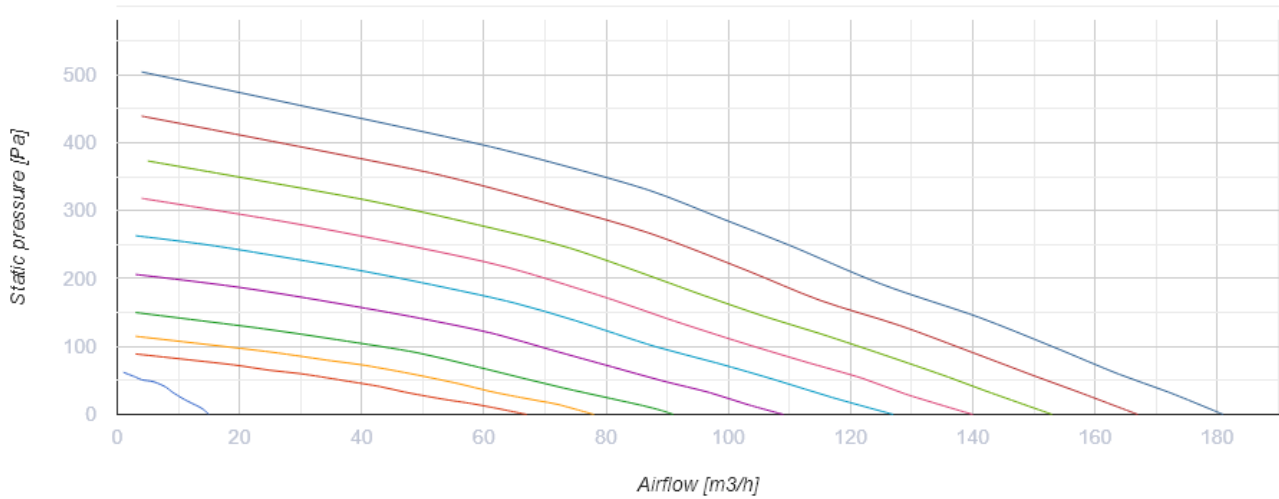

Dimensions

Ø D	H	L	L1	W / B	W1 / B1
160	272	930	627	640	300

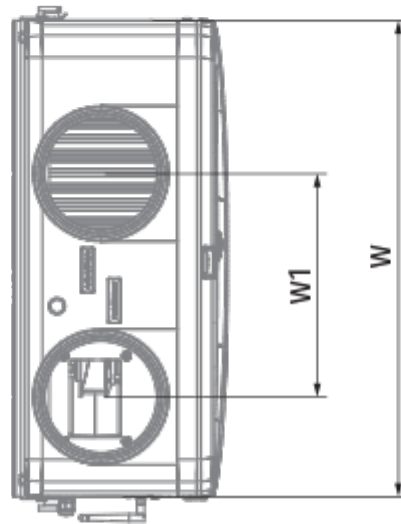
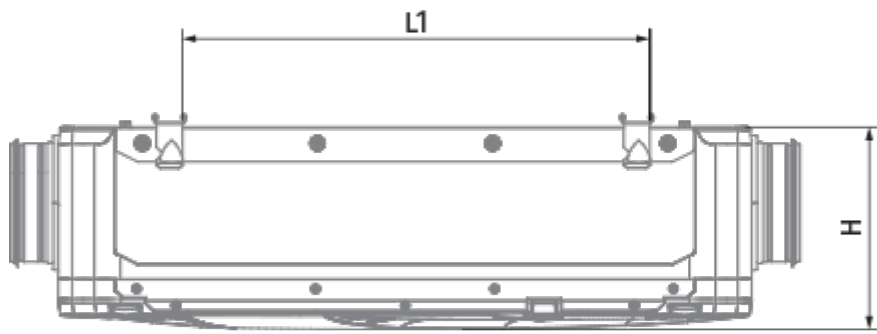
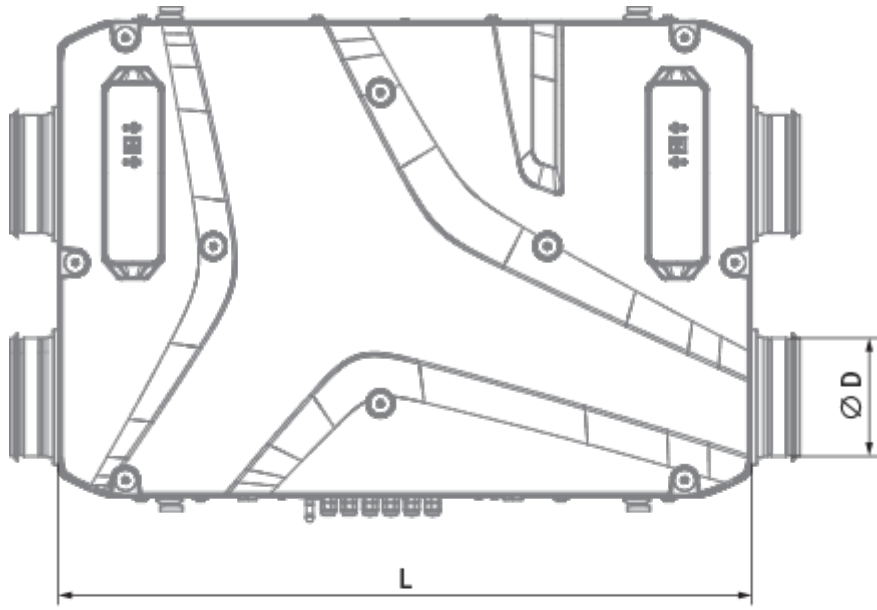

Ecodesign

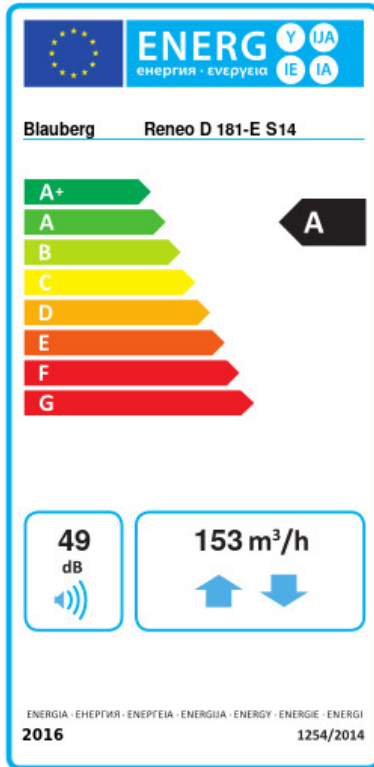

Trademark	Blauberg					
Model	Reneo D 181-E S14					
Specific energy consumption (SEC) (kWh/(m ² /a))	Cold		Average		Warm	
	78	A+	41.1	A	17.3	E
Type of ventilation unit	Bidirectional					
Type of drive installed	Variable speed					
Type of heat recovery system	Recuperative					
Thermal efficiency of heat recovery (%)	77					
Maximum flow rate (m ³ /h)	153					
Electric power input (W)	53					
Reference flow rate (m ³ /s)	0.03					
Reference pressure difference (Pa)	50					
Specific power input (SPI) (W/(m ³ /h))	0.204					
Control typology	Local demand control					
Maximum internal leakage rates (%)	2.7					
Maximum external leakage rates (%)	2.7					
Sound power level (dB(A))	49					
Declared typology	RVU BVU					
The annual electricity consumption (AEC) (kWh/a)	Cold		Average		Warm	
	690		153		108	
The annual heating saved (AHS) (kWh/a)	Cold		Average		Warm	
	8655		4424		2001	

Accessories

Other accessories



Name	Photo	Description
FP 205x200x48 Coarse 90% G4		G4 panel filter

FP 205x200x48 ePM1 60% F7		F7 panel filter
---------------------------	---	-----------------



Other accessories

Name	Photo	Description
EP-Reneo D 181		Decorative panel

Other accessories

Name	Photo	Description
FS2		Humidity sensor
CD-3		
CD-1		CO2 sensors
CD-2		CO2 sensors

Other accessories

Name	Photo	Description
SD 160/600		Silencers for round ducts
SD 160/900		Silencers for round ducts
SD 160/1200		Silencers for round ducts

Other accessories

Name	Photo	Description
------	-------	-------------

VKA 160		Air dampers for round ducts
-------------------------	---	-----------------------------

Other accessories

Name	Photo	Description
Belimo TF230		Electric actuators