

Omega 125 TR

Quiet and energy efficient extract fan

- Maximum airflow: 160
- Sound pressure level LpA at 3 m: 32
- Motor type: AC
- Impeller type: Mixed
- Casing material: Plastic
- Backdraft protection: Backdraft damper
- Timer: Turn off timer, Turn on timer

	Unit of measurement	Omega 125 TR
Connected air duct size	mm	125
Speed	-	1
Minimum supply voltage	V	220
Maximum supply voltage	V	240
Power supply frequency	Hz	50
Rated power	W	17
Unit current	A	0.11
Maximum airflow	m ³ /h	160
rotation speed at 50hz	-	2200
Sound pressure level LpA at 3 m	dB(A)	32
Weight	kg	0
Ambient air temperature min	°C	1
Ambient air temperature max	°C	40
Ingress protection rating	-	IP44

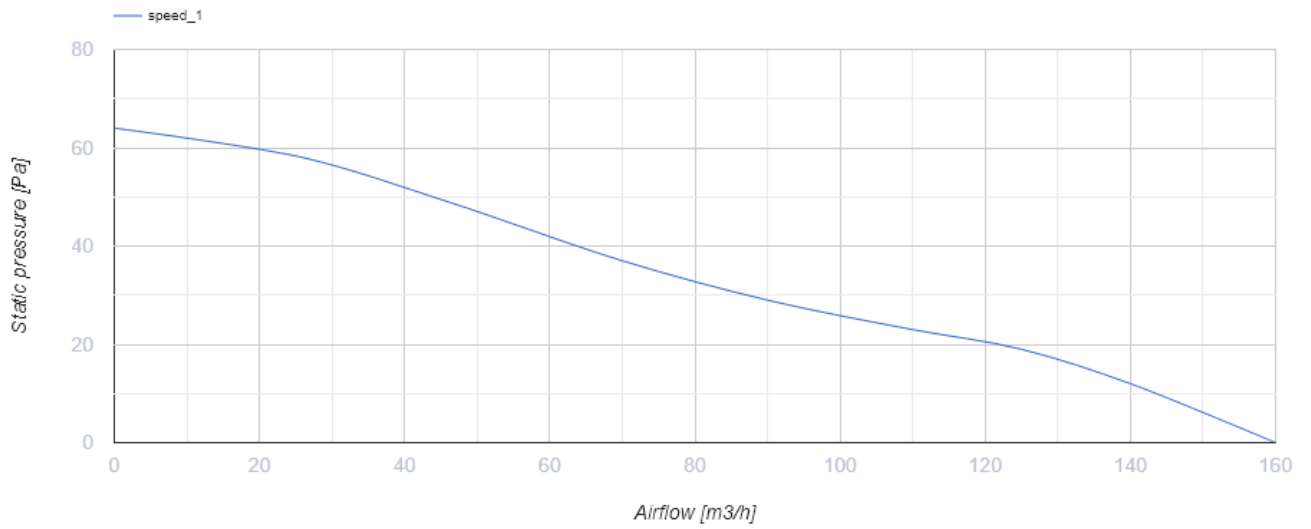

Dimensions

a	Ød	b	c
180	124	85	36

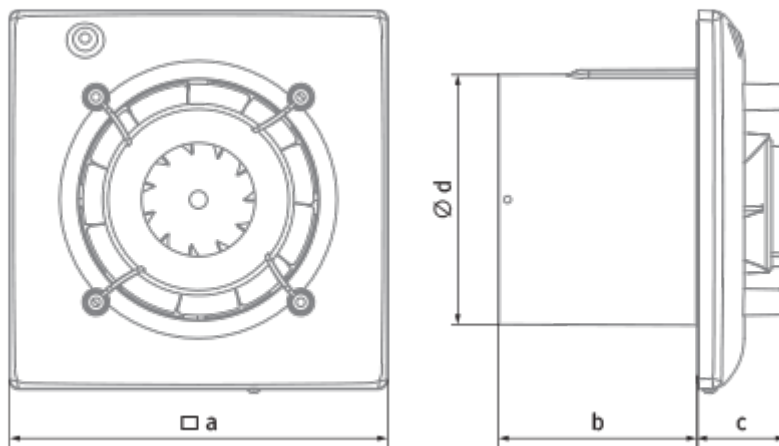

Ecodesign



Trademark	Blauberg					
Model	Omega 125 TR					
Specific energy consumption (SEC) (kWh/(m ² /a))	Cold		Average		Warm	
	-33.5	B	-15.6	E	-5.3	F
Type of ventilation unit	Unidirectional					
Type of drive installed	Single speed					
Type of heat recovery system	None					
Maximum flow rate (m ³ /h)	160					
Electric power input (W)	17					
Reference flow rate (m ³ /s)	0.031					
Specific power input (SPI) (W/(m ³ /h))	0.106					
Control typology	Clock control					
Maximum external leakage rates (%)	2.7					
Declared typology	RVU UVU					
Sound power level (dB(A))	52					
The annual electricity consumption (AEC) (kWh/a)	Cold	Average		Warm		
	126	126		126		
The annual heating saved (AHS) (kWh/a)	Cold	Average		Warm		
	3667	1874		848		