



# Omega 125 (220-240V/60Hz) SH

Quiet and energy efficient extract fan

- Motor type: AC
- Impeller type: Mixed-flow
- Casing material: Plastic
- Backdraft protection: Backdraft damper
- Pull cord
- Humidity sensor
- Timer: Turn off timer

	Unit of measurement	Omega 125 (220-240V/60Hz) SH
Connected air duct size	mm	125
Speed	-	1
Minimum supply voltage	V	220
Maximum supply voltage	V	240
Power supply frequency	Hz	60
Unit current	A	
Ambient air temperature min	°C	1
Ambient air temperature max	°C	40
Ingress protection rating	-	IP44





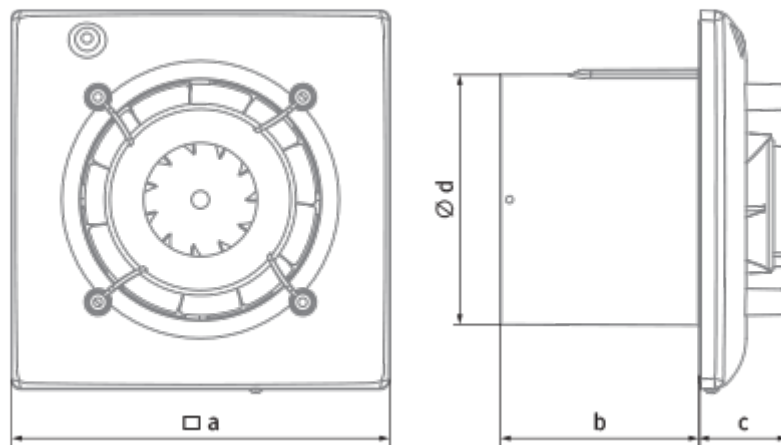



## Dimensions





a	Ød	b	c
180	124	85	36



## Accessories

### Domestic ventilation

Name	Photo	Description
<a href="#">DP 180 Plan</a>		Design Konzept System panels are the finishing touch of your home's ventilation design
<a href="#">DP 180 Plan Red</a>		Design Konzept System panels are the finishing touch of your home's ventilation design
<a href="#">DP 180 Plan Cosmos Black</a>		Design Konzept System panels are the finishing touch of your home's ventilation design
<a href="#">DP 180 Platinum</a>		Design Konzept System panels are the finishing touch of your home's ventilation design
<a href="#">DP 180 Shield</a>		Design Konzept System panels are the finishing touch of your home's ventilation design
<a href="#">DP 180 Bavaria</a>		Design Konzept System panels are the finishing touch of your home's ventilation design
<a href="#">DP 180 Hi-Fi</a>		Design Konzept System panels are the finishing touch of your home's ventilation design
<a href="#">DP 180 Moon</a>		Design Konzept System panels are the finishing touch of your home's ventilation design
<a href="#">DP 180 Chrome</a>		Design Konzept System panels are the finishing touch of your home's ventilation design

<a href="#">DP 180 Hi-Tech</a>		<p>Design Konzept System panels are the finishing touch of your home's ventilation design</p>
<a href="#">DPO 125/180 Glas</a>		<p>Design Konzept System panels are the finishing touch of your home's ventilation design</p>
<a href="#">DPO 125/180 Glas Red</a>		<p>Design Konzept System panels are the finishing touch of your home's ventilation design</p>
<a href="#">DPO 125/180 Glas Black</a>		<p>Design Konzept System panels are the finishing touch of your home's ventilation design</p>