

Omega 100 TR

Quiet and energy efficient extract fan

- Maximum airflow: 90
- Sound pressure level LpA at 3 m: 29
- Motor type: AC
- Impeller type: Mixed-flow
- Casing material: Plastic
- Backdraft protection: Backdraft damper
- Timer: Turn off timer, Turn on timer

	Unit of measurement	Omega 100 TR
Connected air duct size	mm	100
Speed	-	1
Minimum supply voltage	V	220
Maximum supply voltage	V	240
Power supply frequency	Hz	50
Rated power	W	8
Unit current	A	0.05
Maximum airflow	m ³ /h	90
rotation speed at 50hz	-	2165
Sound pressure level LpA at 3 m	dB(A)	29
Weight	kg	0
Ambient air temperature min	°C	1
Ambient air temperature max	°C	40
Ingress protection rating	-	IP44

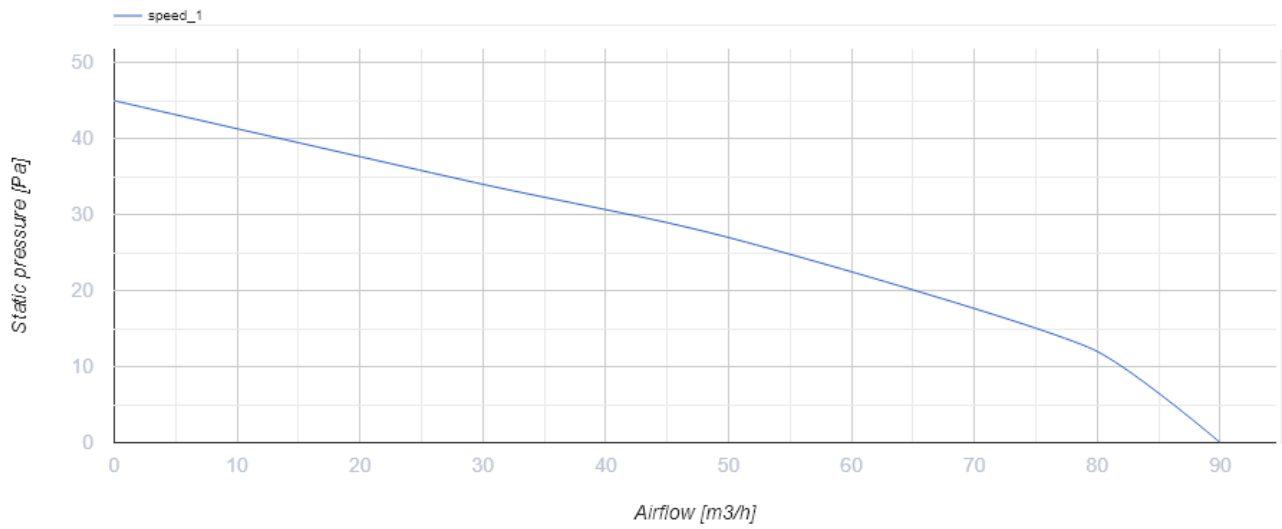

Dimensions

a	Ød	b	c
150	99	79	36

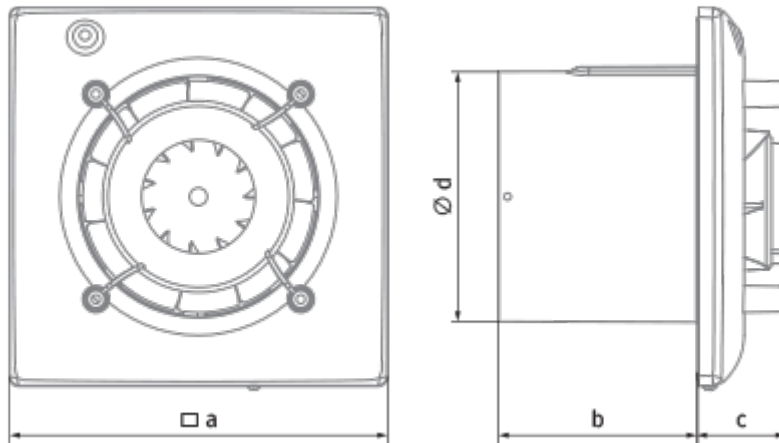



Ecodesign













Trademark	Blauberg					
Model	Omega 100 TR					
Specific energy consumption (SEC) (kWh/(m ² /a))	Cold	Average		Warm		
	-34 A	-16.1 E	-5.8 F			
Type of ventilation unit	Unidirectional					
Type of drive installed	Single speed					
Type of heat recovery system	None					
Maximum flow rate (m ³ /h)	90					
Electric power input (W)	8					
Reference flow rate (m ³ /s)	0.018					
Specific power input (SPI) (W/(m ³ /h))	0.089					
Control typology	Clock control					
Maximum external leakage rates (%)	2.7					
Declared typology	RVU UVU					
Sound power level (dB(A))	49					
The annual electricity consumption (AEC) (kWh/a)	Cold	Average		Warm		
	106	106	106			
The annual heating saved (AHS) (kWh/a)	Cold	Average		Warm		
	3667	1874	848			

Accessories

Domestic ventilation

Name	Photo	Description
DP 180 Plan		Design Konzept System panels are the finishing touch of your home's ventilation design
DP 180 Plan Red		Design Konzept System panels are the finishing touch of your home's ventilation design
DP 180 Plan Cosmos Black		Design Konzept System panels are the finishing touch of your home's ventilation design

DP 180 Platinum		Design Konzept System panels are the finishing touch of your home's ventilation design
DP 180 Shield		Design Konzept System panels are the finishing touch of your home's ventilation design
DP 180 Bavaria		Design Konzept System panels are the finishing touch of your home's ventilation design
DP 180 Hi-Fi		Design Konzept System panels are the finishing touch of your home's ventilation design
DP 180 Moon		Design Konzept System panels are the finishing touch of your home's ventilation design
DP 180 Chrome		Design Konzept System panels are the finishing touch of your home's ventilation design
DP 180 Hi-Tech		Design Konzept System panels are the finishing touch of your home's ventilation design
DPO 100/180 Glas		Design Konzept System panels are the finishing touch of your home's ventilation design
DPO 100/180 Glas Red		Design Konzept System panels are the finishing touch of your home's ventilation design
DPO 100/180 Glas Black		Design Konzept System panels are the finishing touch of your home's ventilation design