



## Omega 100 T

Quiet and energy efficient extract fan

- Maximum airflow: 90
- Sound pressure level LpA at 3 m: 29
- Motor type: AC
- Impeller type: Mixed-flow
- Casing material: Plastic
- Backdraft protection: Backdraft damper
- Timer: Turn off timer

	Unit of measurement	Omega 100 T
Connected air duct size	mm	100
Speed	-	1
Minimum supply voltage	V	220
Maximum supply voltage	V	240
Power supply frequency	Hz	50
Rated power	W	8
Unit current	A	0.05
Maximum airflow	m <sup>3</sup> /h	90
rotation speed at 50hz	-	2165
Sound pressure level LpA at 3 m	dB(A)	29
Weight	kg	0
Ambient air temperature min	°C	1
Ambient air temperature max	°C	40
Ingress protection rating	-	IP44

### Dimensions

a	Ød	b	c
150	99	79	36

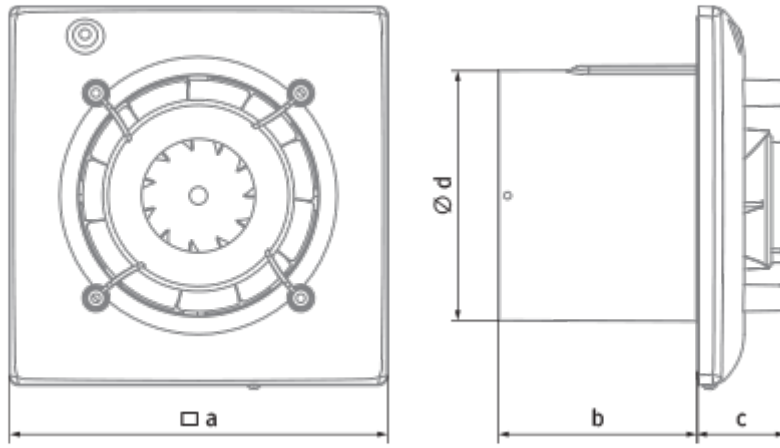



## Ecodesign













Trademark	Blauberg					
Model	Omega 100 T					
Specific energy consumption (SEC) (kWh/(m <sup>2</sup> /a))	Cold	Average		Warm		
	-34 A	-16.1 E	-5.8 F			
Type of ventilation unit	Unidirectional					
Type of drive installed	Single speed					
Type of heat recovery system	None					
Maximum flow rate (m <sup>3</sup> /h)	90					
Electric power input (W)	8					
Reference flow rate (m <sup>3</sup> /s)	0.018					
Specific power input (SPI) (W/(m <sup>3</sup> /h))	0.089					
Control typology	Clock control					
Maximum external leakage rates (%)	2.7					
Declared typology	RVU UVU					
Sound power level (dB(A))	49					
The annual electricity consumption (AEC) (kWh/a)	Cold	Average		Warm		
	106	106	106			
The annual heating saved (AHS) (kWh/a)	Cold	Average		Warm		
	3667	1874	848			

## Accessories

### Decorative panels

Name	Photo	Description
<a href="#">DP 180 Plan</a>		Design Konzept System panels are the finishing touch of your home's ventilation design
<a href="#">DP 180 Plan Red</a>		Design Konzept System panels are the finishing touch of your home's ventilation design
<a href="#">DP 180 Plan Cosmos Black</a>		Design Konzept System panels are the finishing touch of your home's ventilation design

<a href="#">DP 180 Platinum</a>		Design Konzept System panels are the finishing touch of your home's ventilation design
<a href="#">DP 180 Shield</a>		Design Konzept System panels are the finishing touch of your home's ventilation design
<a href="#">DP 180 Bavaria</a>		Design Konzept System panels are the finishing touch of your home's ventilation design
<a href="#">DP 180 Hi-Fi</a>		Design Konzept System panels are the finishing touch of your home's ventilation design
<a href="#">DP 180 Moon</a>		Design Konzept System panels are the finishing touch of your home's ventilation design
<a href="#">DP 180 Chrome</a>		Design Konzept System panels are the finishing touch of your home's ventilation design
<a href="#">DP 180 Hi-Tech</a>		Design Konzept System panels are the finishing touch of your home's ventilation design
<a href="#">DPO 100/180 Glas</a>		Design Konzept System panels are the finishing touch of your home's ventilation design
<a href="#">DPO 100/180 Glas Red</a>		Design Konzept System panels are the finishing touch of your home's ventilation design
<a href="#">DPO 100/180 Glas Black</a>		Design Konzept System panels are the finishing touch of your home's ventilation design