



Omega 100

Quiet and energy efficient extract fan

- Maximum airflow: 90
- Sound pressure level LpA at 3 m: 29
- Motor type: AC
- Impeller type: Mixed
- Casing material: Plastic
- Backdraft protection: Backdraft damper

	Unit of measurement	Omega 100
Connected air duct size	mm	100
Speed	-	1
Minimum supply voltage	V	220
Maximum supply voltage	V	240
Power supply frequency	Hz	50
Rated power	W	8
Unit current	A	0.05
Maximum airflow	m ³ /h	90
rotation speed at 50hz	-	2165
Sound pressure level LpA at 3 m	dB(A)	29
Weight	kg	0
Ambient air temperature min	°C	1
Ambient air temperature max	°C	40
Ingress protection rating	-	IP44

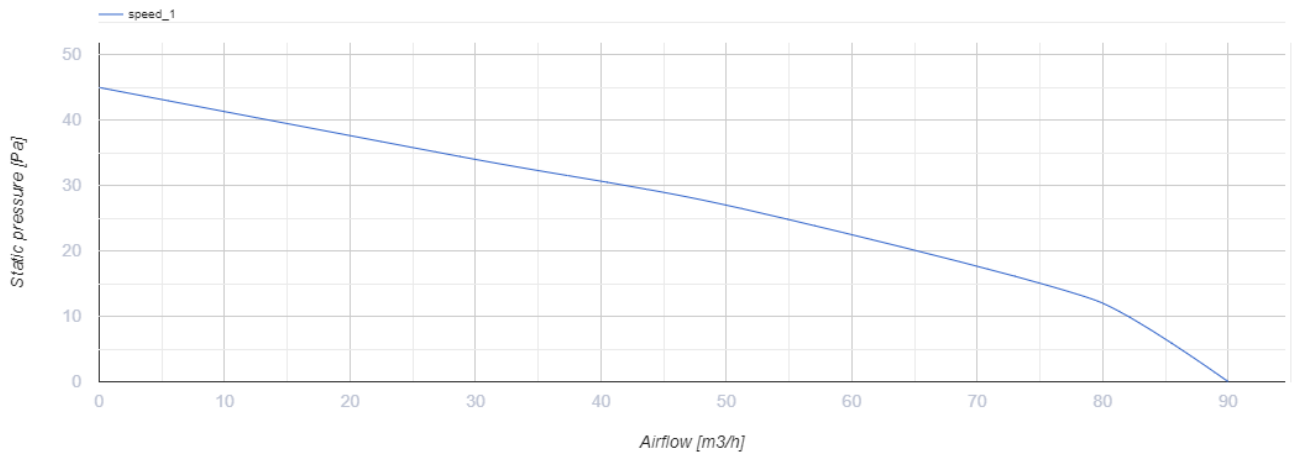

Dimensions

a	Ød	b	c
150	99	79	36

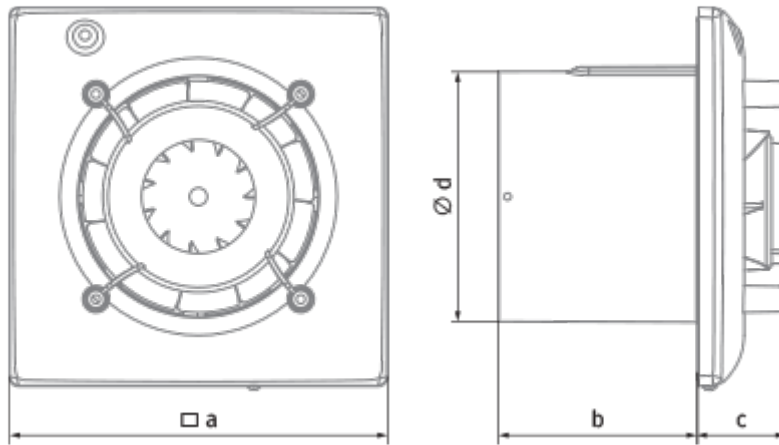

Ecodesign



Trademark	Blauberg					
Model	Omega 100					
Specific energy consumption (SEC) (kWh/(m ² /a))	Cold		Average		Warm	
	-30.8	B	-14.4	E	-5	F
Type of ventilation unit	Unidirectional					
Type of drive installed	Single speed					
Type of heat recovery system	None					
Maximum flow rate (m ³ /h)	90					
Electric power input (W)	8					
Reference flow rate (m ³ /s)	0.018					
Specific power input (SPI) (W/(m ³ /h))	0.089					
Control typology	Manual control					
Maximum external leakage rates (%)	2.7					
Declared typology	RVU UVU					
Sound power level (dB(A))	49					
The annual electricity consumption (AEC) (kWh/a)	Cold		Average		Warm	
	111		111		111	
The annual heating saved (AHS) (kWh/a)	Cold		Average		Warm	
	3355		1715		776	