

O2 Supreme white

Blauberg O2 Supreme - your solution for intelligent and efficient exhaust ventilation in any space.

- Maximum airflow: 140
- Sound pressure level LpA at 3 m: 28
- Lighting
- Motor type: DC
- Control: Smartphone
- Impeller type: Axial
- Motion sensor
- Humidity sensor: Built-in
- VOC sensor
- Timer: Turn off timer, Turn on timer

	Unit of measurement	O2 Supreme white	
Connected air duct size	mm	100	125
Speed	-	1	
Minimum supply voltage	V	100	
Maximum supply voltage	V	240	
Power supply frequency	Hz	50/60	
Rated power	W	2.7	2.9
Unit current	A	0.038	0.04
Maximum airflow	m ³ /h	115	140
Sound pressure level LpA at 3 m	dB(A)	27	28
Ambient air temperature min	°C	1	
Ambient air temperature max	°C	40	
Ingress protection rating	-	IP44 Zone 1	

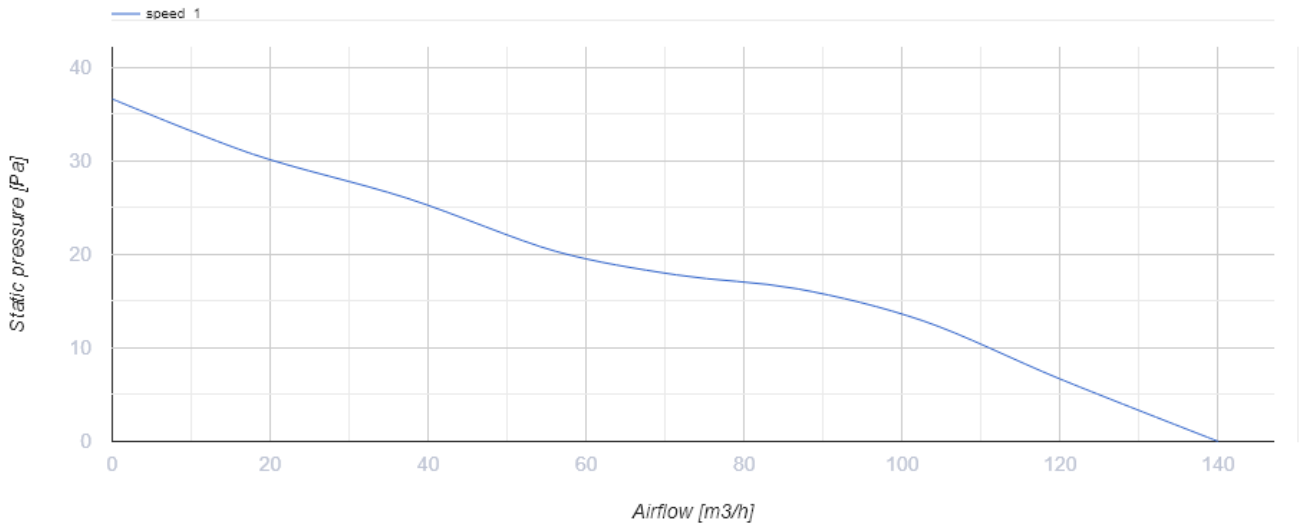
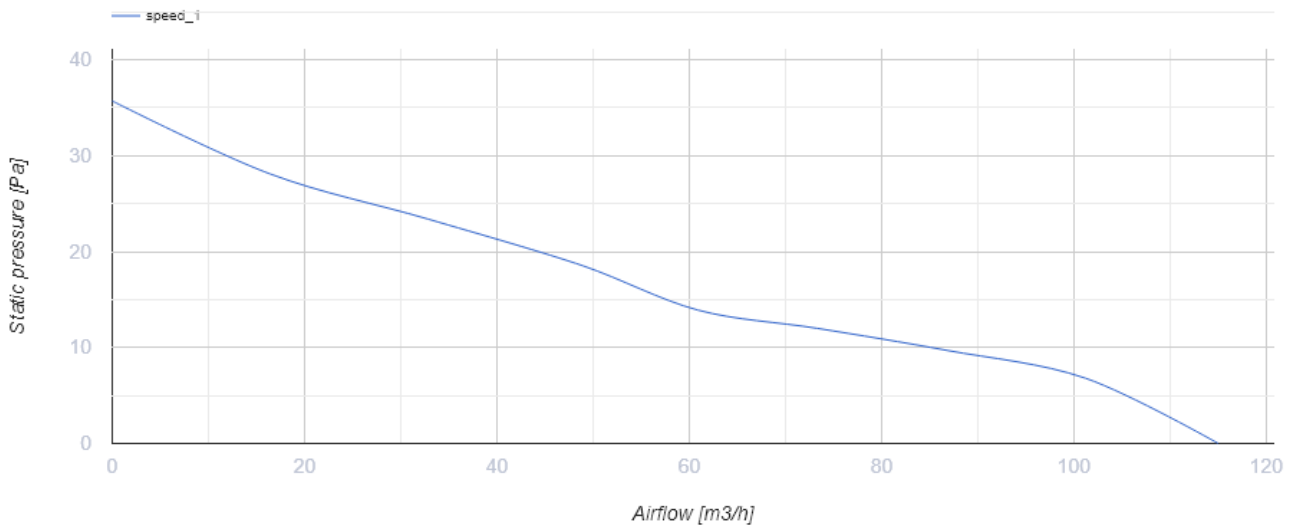

Dimensions

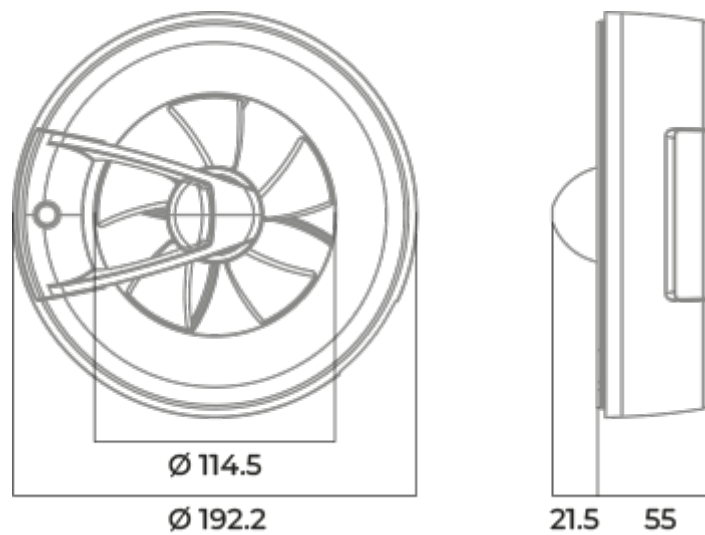

Ecodesign



Trademark	Blauberg					
Model	O2 Supreme white					
Specific energy consumption (SEC) (kWh/(m ² /a))	Cold		Average		Warm	
	55.1	A+	28.1	B	12.6	E
Type of ventilation unit	Unidirectional					
Type of drive installed	Variable speed					
Type of heat recovery system	None					
Maximum flow rate (m ³ /h)	140					
Electric power input (W)	2.9					
Reference flow rate (m ³ /s)	0.025					
Specific power input (SPI) (W/(m ³ /h))	0.018					
Control typology	Local demand control					
Maximum external leakage rates (%)	2.7					
Sound power level (dB(A))	42					
Declared typology	RVU UVU					
The annual heating saved (AHS) (kWh/a)	Cold		Average		Warm	
	5536		2830		1280	

Accessories

Flat duct

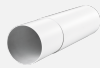

Name	Photo	Description
BlauPlast RTR 100/0.35-0.5		Round telescopic duct
BlauPlast RTR 125/0.35-0.5		Round telescopic duct

Hoods

Name	Photo	Description
Decor S 102 HK		Metal hoods

Decor S 137x137/102HK		Metal hoods
Decor S 167x167/122HK		Metal hoods

Hoods

Name	Photo	Description
Decor 155x155H		Plastic hoods
Decor 185x185H		Plastic hoods

Plastic

Name	Photo	Description
Decor 155x155s		Plastic grilles for supply and exhaust ventilation
Decor 185x185s		Plastic grilles for supply and exhaust ventilation