

MRDL 630

Mounting frames

- Casing material: Galvanized steel

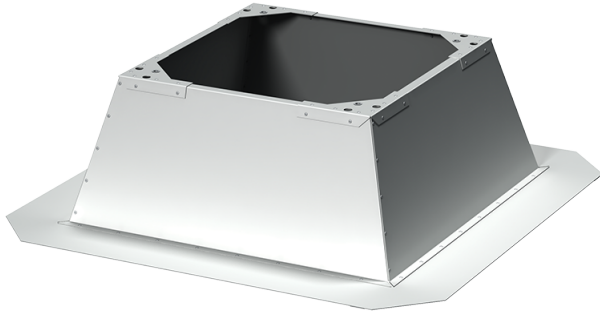

	Unit of measurement	MRDL 630
Weight	kg	65.9

Dimensions

B	B1	H	L	L1
1212	852	600,0	912	750

