

MRDL 220-225

Mounting frames

- Casing material: Galvanized steel

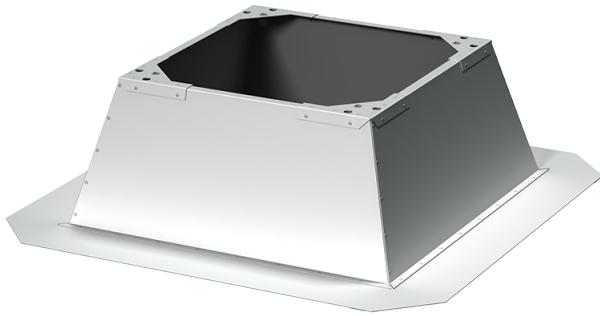

| | Unit of measurement | MRDL 220-225 |
|--------|---------------------|--------------|
| Weight | kg | 10.4 |

Dimensions

| B | B1 | H | L | L1 |
|-----|-----|-------|-----|-----|
| 720 | 254 | 300,5 | 301 | 245 |

