



# KOMFORT Ultra EC L2 300-E S2 white

Compact heat recovery air handling units

- Maximum airflow: 300
- Sound pressure level LpA at 3 m: 33
- Heat exchanger type: Cross flow
- Extract filter: G4
- Supply filter: G4, F8
- Sound insulation
- Motor type: EC
- Enthalpy heat exchanger
- Control: Speed controller
- Casing material: Double-skinned white painted metal panels
- CO2 sensor: Optional
- VOC sensor: Optional
- PM2.5 sensor: Optional

	Unit of measurement	KOMFORT Ultra EC L2 300-E S2 white
Connected air duct size	mm	125
Speed	-	1
Phases	-	1
Minimum supply voltage	V	230
Maximum supply voltage	V	230
Power supply frequency	Hz	50/60
Rated power	W	165
Unit current	A	1.3
Maximum airflow	m <sup>3</sup> /h	300
Sound pressure level LpA at 3 m	dB(A)	33
Heat recovery efficiency, max	%	73
Heat exchanger type	-	Cross flow
Heat exchanger material	-	Enthalpy
Weight	kg	28
Extract filter	-	G4
Supply filter	-	G4, F8
Transported air temperature (max)	°C	60
Transported air temperature (min)	°C	-25
Ambient air temperature min	°C	1
Ambient air temperature max	°C	40

Ambient air humidity max	%	80
Ingress protection rating	-	IP22
Ingress protection rating of the drive	-	IP44

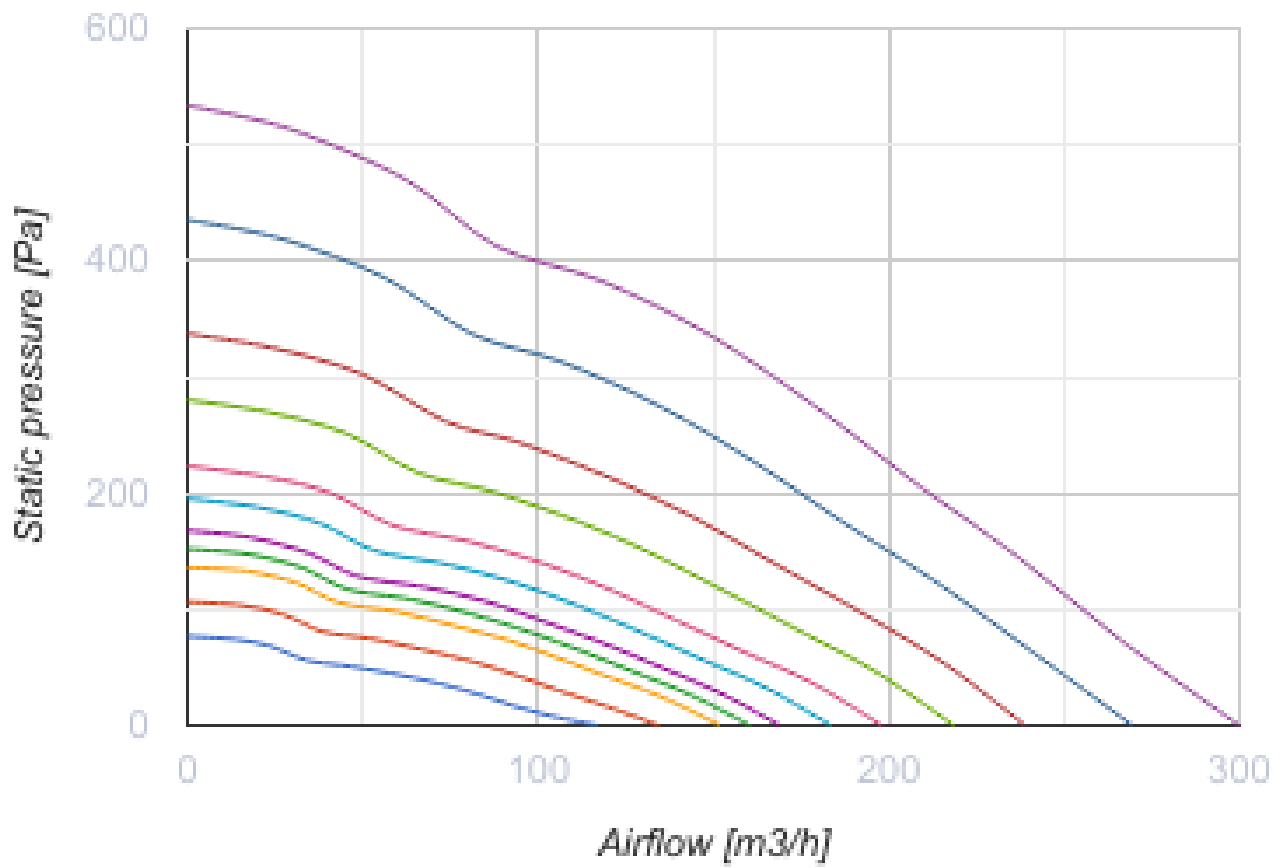

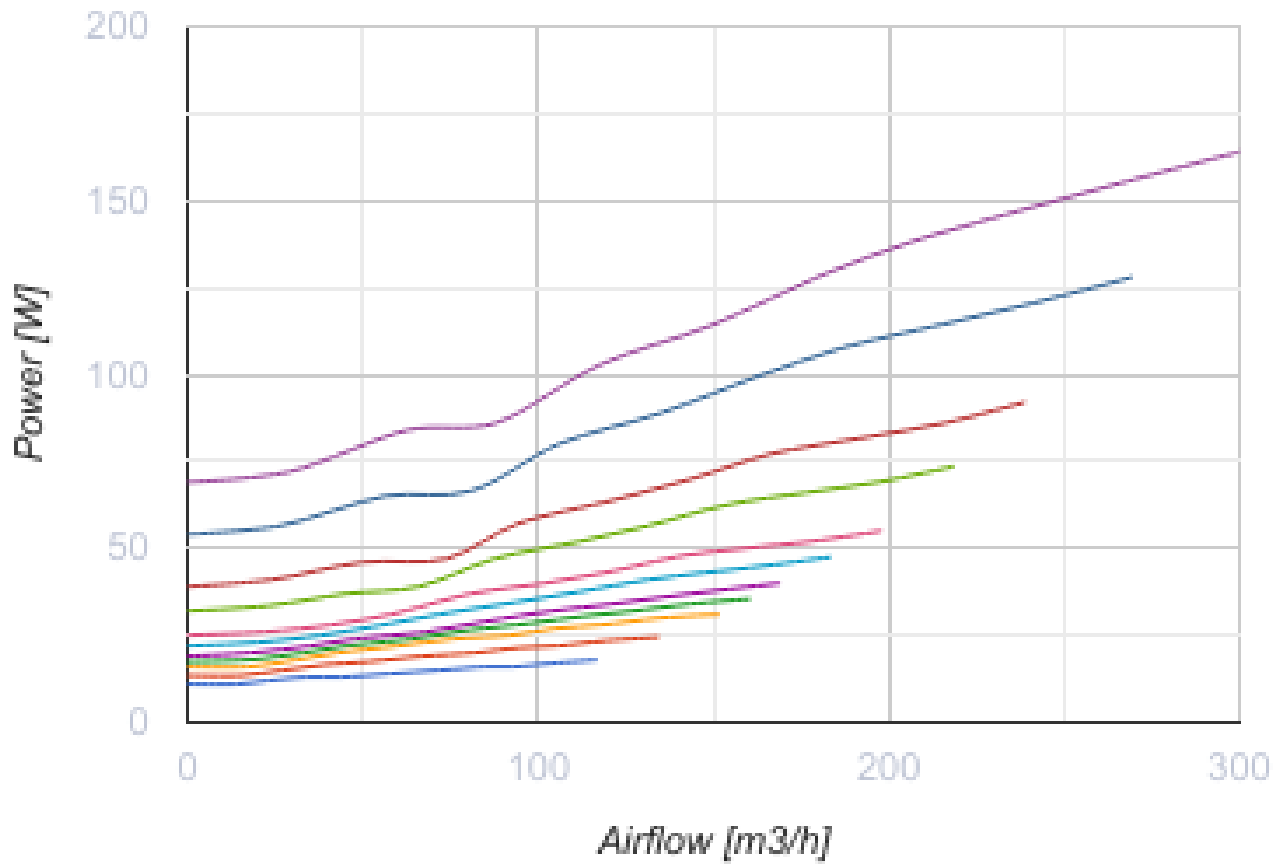

## Dimensions

ØD	B	H	H1	L	L1
125	300	443	43	713	810

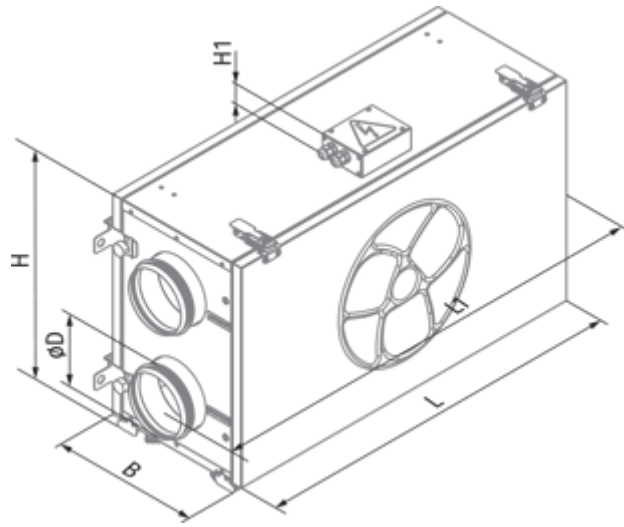

## Ecodesign

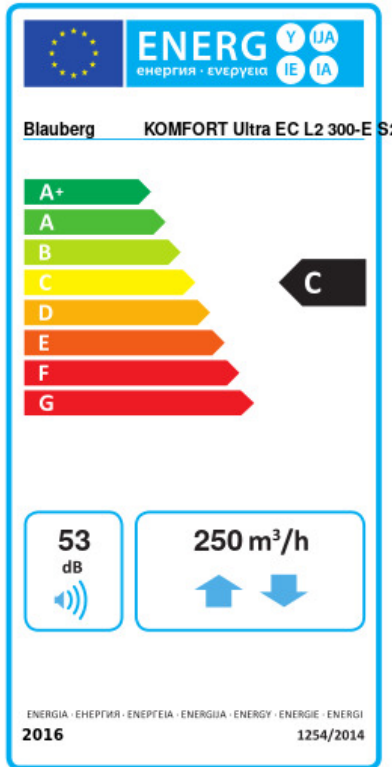

Trademark	Blauberg					
Model	KOMFORT Ultra EC L2 300-E S2 white					
Specific energy consumption (SEC) (kWh/(m²/a))	Cold		Average		Warm	
	54.1	A+	25.4	C	6.3	F
Type of ventilation unit	Bidirectional					
Type of drive installed	Variable speed					
Type of heat recovery system	Recuperative					
Thermal efficiency of heat recovery (%)	58					
Maximum flow rate (m³/h)	250					
Electric power input (W)	150					
Reference flow rate (m³/s)	0.044					
Reference pressure difference (Pa)	50					
Specific power input (SPI) (W/(m³/h))	0.313					
Control typology	Manual control					
Maximum internal leakage rates (%)	2.7					
Maximum external leakage rates (%)	2.7					
Sound power level (dB(A))	53					
Declared typology	RVU BVU					
The annual electricity consumption (AEC) (kWh/a)	Cold		Average		Warm	
	973		436		391	
The annual heating saved (AHS) (kWh/a)	Cold		Average		Warm	
	6969		3563		1611	



## Accessories

### Other accessories

Name	Photo	Description
FP 240x184x40 G4		G4 panel filter
FP 240x184x40 F8		

SB C4 200/240

**Other accessories**

Name	Photo	Description
<a href="#">SD 125/600</a>		Silencers for round ducts
<a href="#">SD 125/900</a>		Silencers for round ducts
<a href="#">SD 125/1200</a>		Silencers for round ducts

**Other accessories**

Name	Photo	Description
<a href="#">VRV 125</a>		Backdraft dampers with spring for round ducts