



KOMFORT Roto EC S6K 200 S21

Air handling units with rotary heat exchanger

- Maximum airflow: 270
- Sound pressure level LpA at 3 m: 28
- Heat exchanger type: Rotary
- Extract filter: G4
- Supply filter: G4 + F7
- Sound insulation
- Motor type: EC
- BMS protocol: ModBus
- Control: Smartphone
- Casing material: Galvanized steel
- Humidity sensor: Optional
- CO2 sensor: Optional
- VOC sensor: Optional
- PM2.5 sensor: Optional

	Unit of measurement	KOMFORT Roto EC S6K 200 S21
Connected air duct size	mm	125
Speed	-	1
Phases	-	1
Minimum supply voltage	V	230
Maximum supply voltage	V	230
Power supply frequency	Hz	50/60
Rated power	W	118
Power of electrical reheater	W	0
Unit current	A	1
Maximum airflow	m ³ /h	270
rotation speed at 50hz	-	1800
Sound pressure level LpA at 3 m	dB(A)	28
Heat recovery efficiency, max	%	92
Heat exchanger type	-	Rotary
Heat exchanger material	-	Aluminum
Weight	kg	48
Extract filter	-	G4
Supply filter	-	G4 + F7
Transported air temperature (max)	°C	40
Transported air temperature (min)	°C	-25
Ambient air temperature min	°C	1

Ambient air temperature max	°C	40
Ambient air humidity max	%	60
Ingress protection rating	-	IP22
Ingress protection rating of the drive	-	IP44

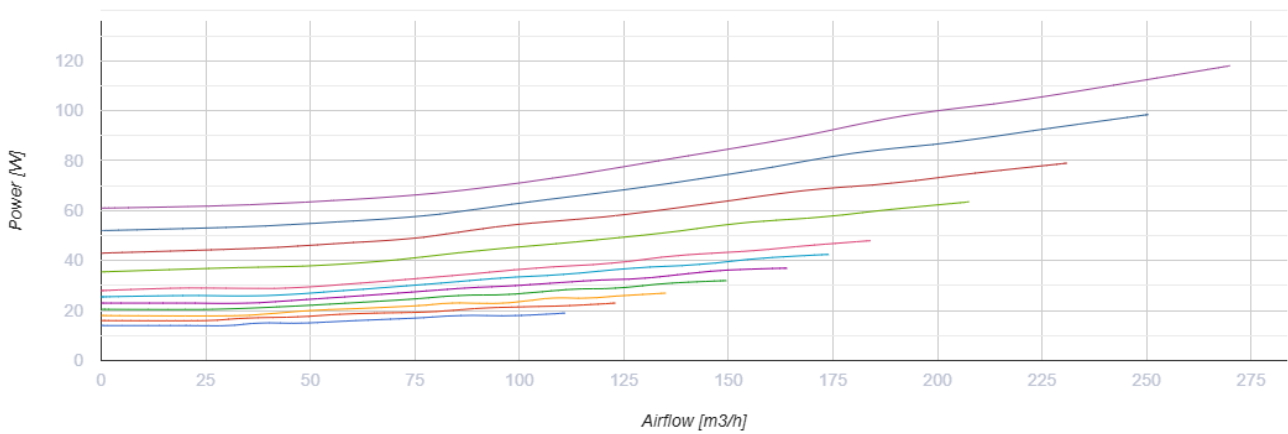
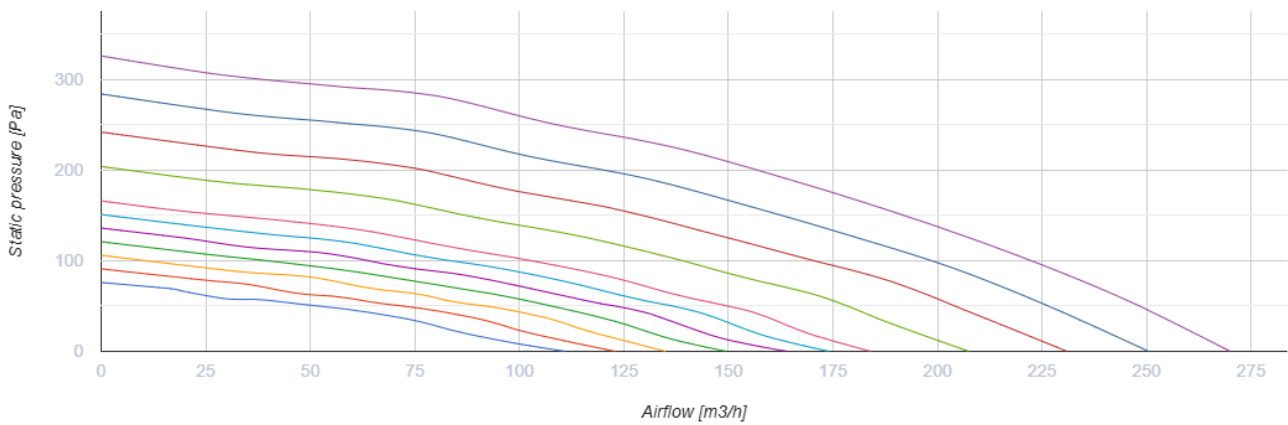

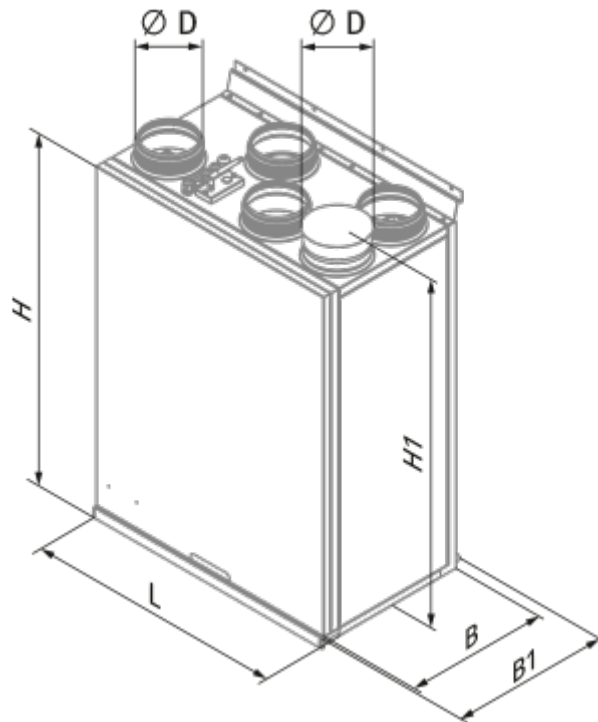

Dimensions

Ø D	B	B1	H	H1	L
125	348	371	791	865	598





Accessories

Other accessories



Name	Photo	Description
FP 284x103x60 G4		G4 panel filter
FP 284x103x60 F7		F7 panel filter

Other accessories



Name	Photo	Description
S22		Control panels
S22 Wi-Fi		Control panels

S25		LCD control panel
---------------------	---	-------------------

Other accessories

Name	Photo	Description
FS2		Humidity sensor
CD-1		CO2 sensors
CD-2		CO2 sensors

Other accessories

Name	Photo	Description
SD 125/600		Silencers for round ducts
SD 125/900		Silencers for round ducts
SD 125/1200		Silencers for round ducts

Other accessories

Name	Photo	Description
VRV 125		Backdraft dampers with spring for round ducts
VKA 125		Air dampers for round ducts