

KOMFORT Roto EC LW 2000-2 S17

Air handling units with rotary heat exchanger

- Maximum airflow: 2250
- Sound pressure level LpA at 3 m: 64
- Heat exchanger type: Rotary
- Extract filter: G4
- Supply filter: G4
- Sound insulation
- Motor type: EC
- Reheater: Water
- Control: Wired control panel
- Casing material: Aluzinc steel
- Humidity sensor: Optional
- CO2 sensor: Optional
- VOC sensor: Optional
- PM2.5 sensor: Optional

	Unit of measurement	KOMFORT Roto EC LW 2000-2 S17
Connected air duct size	mm	500x300
Speed	-	1
Phases	-	1
Minimum supply voltage	V	230
Maximum supply voltage	V	230
Power supply frequency	Hz	50/60
Rated power	W	1070
Unit current	A	5
Maximum airflow	m ³ /h	2250
Sound pressure level LpA at 3 m	dB(A)	64
Heat recovery efficiency, max	%	93
Heat exchanger type	-	Rotary
Heat exchanger material	-	Aluminum
Weight	kg	198
Extract filter	-	G4
Supply filter	-	G4
Transported air temperature (max)	°C	40
Transported air temperature (min)	°C	-25
Ambient air temperature min	°C	1
Ambient air temperature max	°C	40

Ambient air humidity max	%	80
Ingress protection rating	-	IP22
Ingress protection rating of the drive	-	IP44

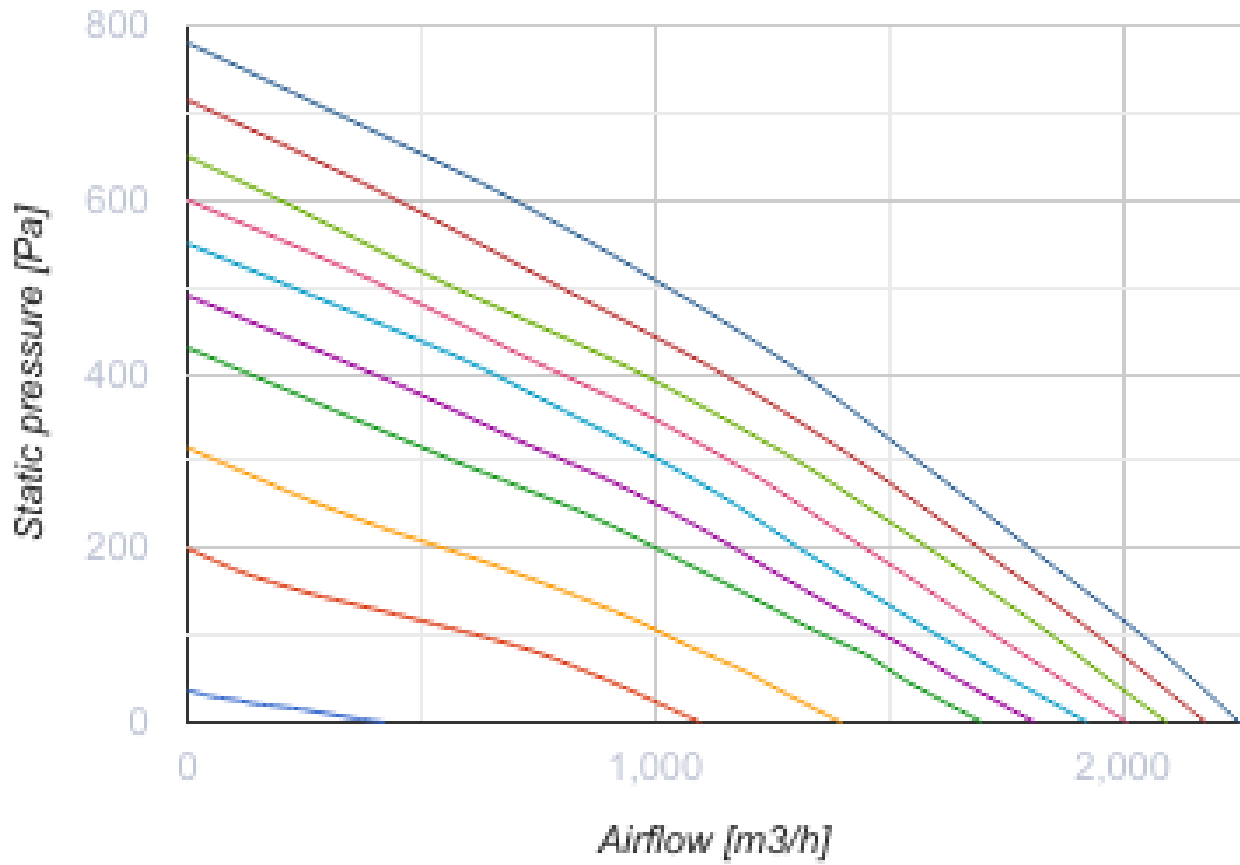

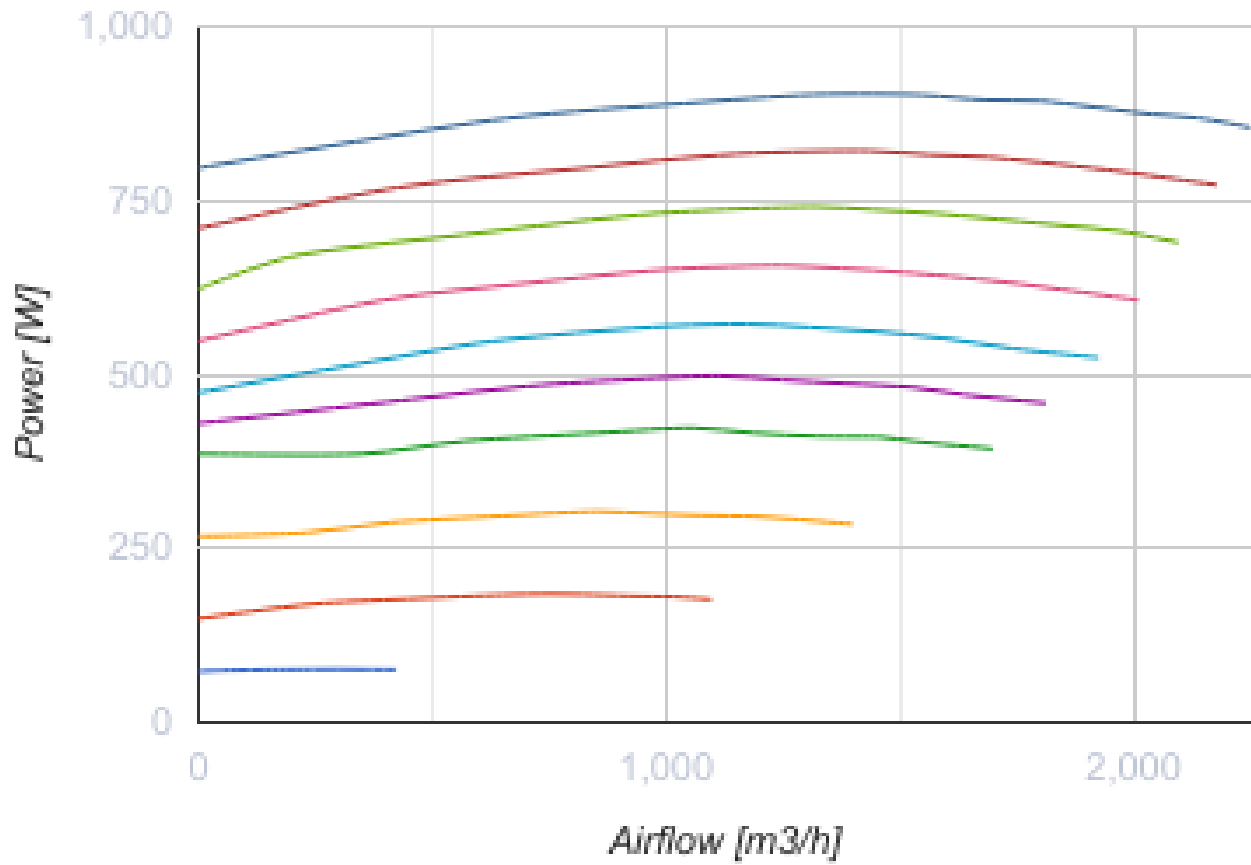

Dimensions

B	B1	H	L	X	Y
875	630	1010	1485	500	300

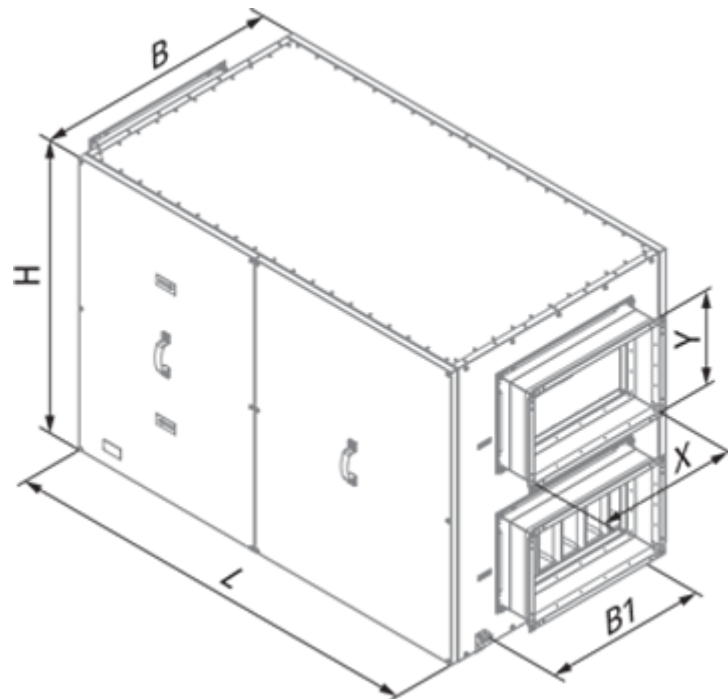

Accessories

Other accessories

Name	Photo	Description
FP 800x477x47 G4		G4 panel filter
FPT 800x477x27 G4		

Mixing chambers

Name	Photo	Description
WMG 1-6		Water mixing units

For rectangular ducts

Name	Photo	Description
VRVS 50x30		Backdraft air dampers for rectangular ducts

VK 50x30		Air dampers for rectangular ducts
--------------------------	---	-----------------------------------

Humidity sensors

Name	Photo	Description
FS2		Humidity sensor