



# KOMFORT Roto EC LW 1000-2 S18

Air handling units with rotary heat exchanger

- Maximum airflow: 900
- Sound pressure level LpA at 3 m: 58
- Heat exchanger type: Rotary
- Extract filter: G4
- Supply filter: G4
- Sound insulation
- Motor type: EC
- Reheater: Water
- Control: Wired control panel
- Casing material: Aluzinc steel
- Humidity sensor: Optional
- CO2 sensor: Optional
- VOC sensor: Optional
- PM2.5 sensor: Optional

	Unit of measurement	KOMFORT Roto EC LW 1000-2 S18
Connected air duct size	mm	250
Speed	-	1
Phases	-	1
Minimum supply voltage	V	230
Maximum supply voltage	V	230
Power supply frequency	Hz	50/60
Rated power	W	440
Unit current	A	1.9
Maximum airflow	m <sup>3</sup> /h	900
Sound pressure level LpA at 3 m	dB(A)	58
Heat recovery efficiency, max	%	95
Heat exchanger type	-	Rotary
Heat exchanger material	-	Aluminum
Weight	kg	130
Extract filter	-	G4
Supply filter	-	G4
Transported air temperature (max)	°C	40
Transported air temperature (min)	°C	-25
Ambient air temperature min	°C	1
Ambient air temperature max	°C	40

Ambient air humidity max	%	80
Ingress protection rating	-	IP22
Ingress protection rating of the drive	-	IP44

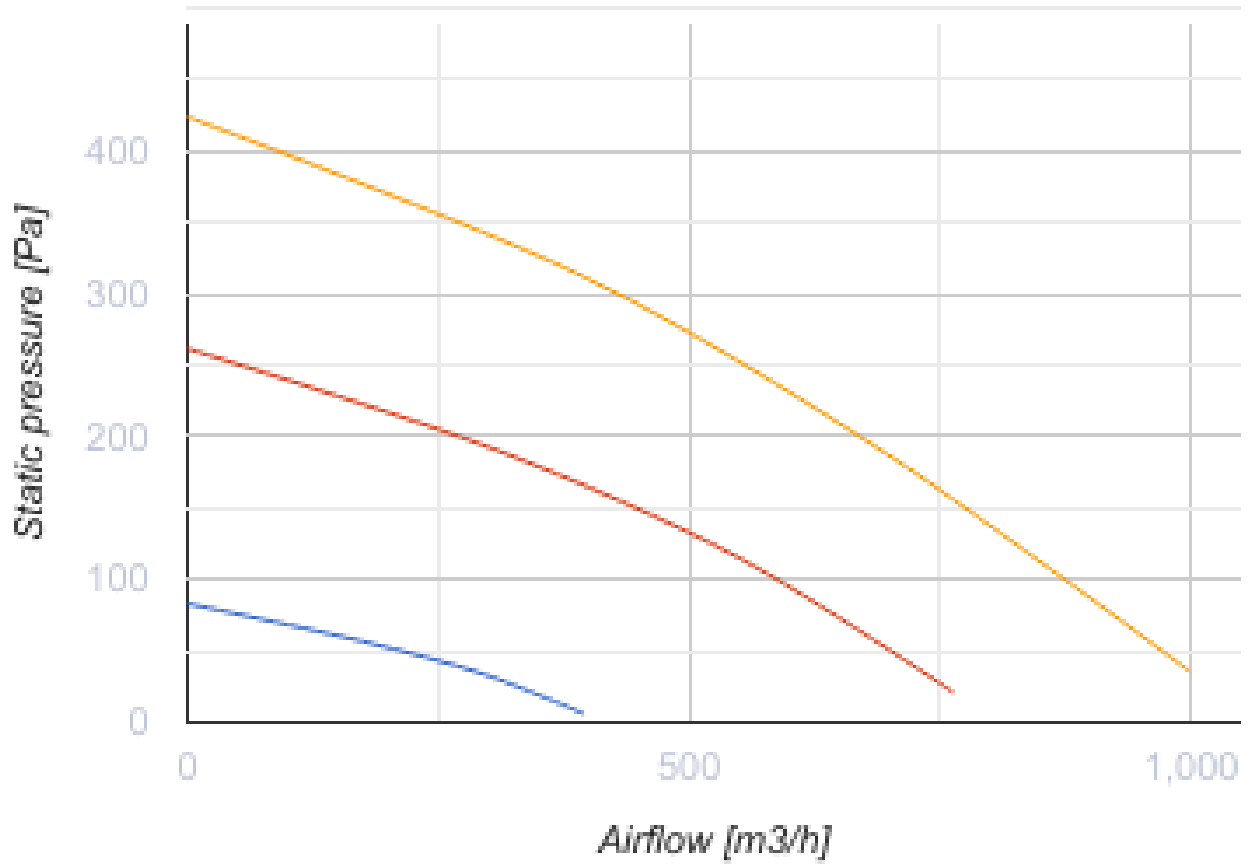

## Dimensions

ØD	B	B1	H	L
249	745	580	700	1210

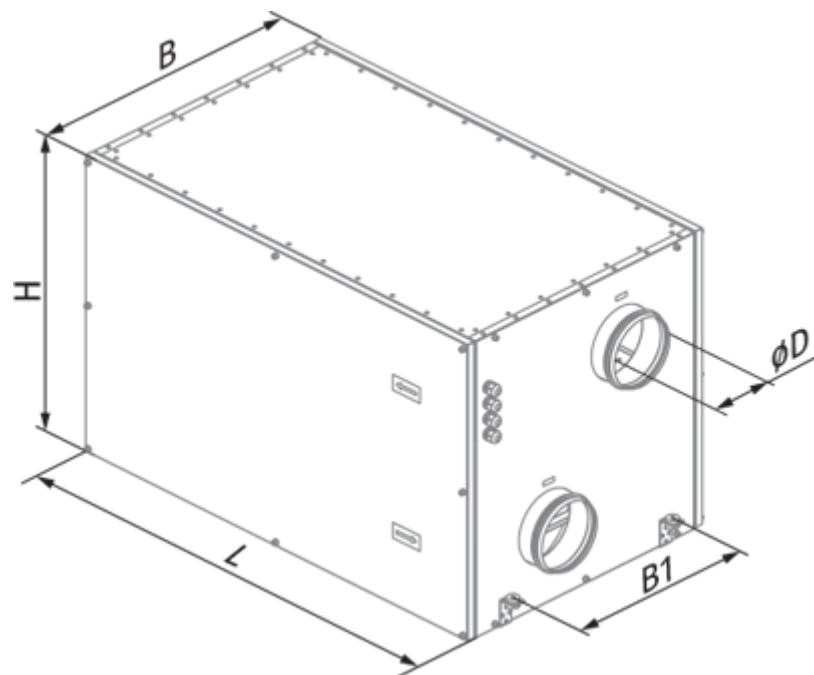

## Accessories



### Other accessories

Name	Photo	Description
FP 700x332x48 G4		G4 panel filter
FPT 700x333x27 G4		

### Mixing chambers



Name	Photo	Description
<a href="#">WMG 3/4-4</a>		Water mixing units

### For round ducts

Name	Photo	Description
<a href="#">SD 250/600</a>		Silencers for round ducts
<a href="#">SD 250/900</a>		Silencers for round ducts

<a href="#">SD 250/1200</a>		Silencers for round ducts
-----------------------------	---	---------------------------

### For round ducts

Name	Photo	Description
<a href="#">VRV 250</a>		Backdraft dampers with spring for round ducts
<a href="#">VRVS 250</a>		Backdraft air dampers for round ducts

### Humidity sensors

Name	Photo	Description
<a href="#">FS2</a>		Humidity sensor