

# KOMFORT Roto EC LEHP 900 S18

Compact heat recovery air handling units



- Power of electrical preheater: 2800
- Maximum airflow: 955
- Sound pressure level LpA at 3 m: 58
- Heat exchanger type: Rotary
- Extract filter: G4
- Supply filter: G4 (опция: F7), G4 (option: F7)
- Sound insulation
- Motor type: EC
- Preheater: Built-in
- Control: Wired control panel
- Casing material: Aluzinc steel
- Humidity sensor: Optional
- CO2 sensor: Optional
- VOC sensor: Optional
- PM2.5 sensor: Optional

	Unit of measurement	KOMFORT Roto EC LEHP 900 S18
Connected air duct size	mm	250
Speed	-	1
Phases	-	1
Minimum supply voltage	V	230
Maximum supply voltage	V	230
Power supply frequency	Hz	50
Rated power	W	1195
Power of electrical preheater	W	2800
Unit current	A	19.4
Maximum airflow	m <sup>3</sup> /h	955
Sound pressure level LpA at 3 m	dB(A)	58
Heat recovery efficiency, max	%	85
Heat exchanger type	-	Rotary
Heat exchanger material	-	Aluminum
Weight	kg	165
Extract filter	-	G4
Supply filter	-	G4 (опция: F7), G4 (option: F7)
Transported air temperature (max)	°C	40
Transported air temperature (min)	°C	-25
Ambient air temperature min	°C	1
Ambient air temperature max	°C	40

Ambient air humidity max	%	80
Ingress protection rating	-	IP22
Ingress protection rating of the drive	-	IP44

## Dimensions

ØD	B	H	L
249	748	750	1667

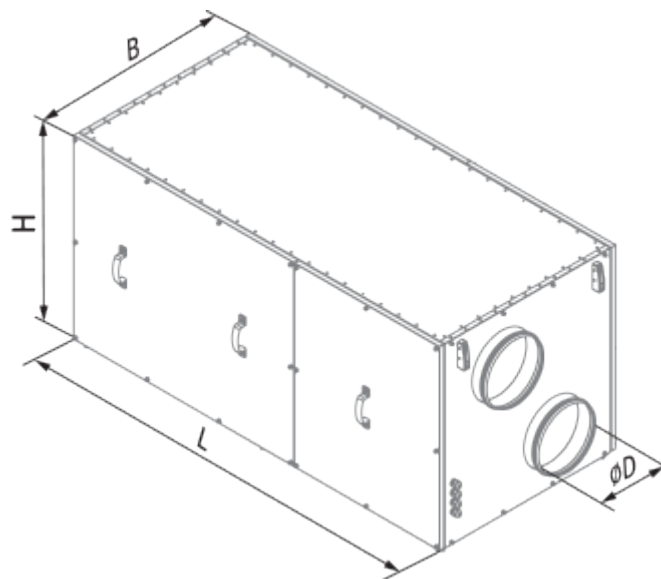



## Accessories

### Other accessories

Name	Photo	Description
FP 700x352x48 G4		G4 panel filter
FPT 700x351x27 G4		
FPT 700x351x27 F7		

### For round ducts

Name	Photo	Description
<a href="#">VRV 250</a>		Backdraft dampers with spring for round ducts

<a href="#">VKA 250</a>		Air dampers for round ducts
-------------------------	---	-----------------------------

### Humidity sensors

Name	Photo	Description
<a href="#">FS2</a>		Humidity sensor