

KOMFORT Roto EC LEHP 700 S18

Compact heat recovery air handling units



- Power of electrical preheater: 2800
- Maximum airflow: 830
- Sound pressure level LpA at 3 m: 52
- Heat exchanger type: Rotary
- Extract filter: G4
- Supply filter: G4 (опция: F7), G4 (option: F7)
- Sound insulation
- Motor type: EC
- Preheater: Built-in
- Control: Wired control panel
- Casing material: Aluzinc steel
- Humidity sensor: Optional
- CO2 sensor: Optional
- VOC sensor: Optional
- PM2.5 sensor: Optional

	Unit of measurement	KOMFORT Roto EC LEHP 700 S18
Connected air duct size	mm	250
Speed	-	1
Phases	-	1
Minimum supply voltage	V	230
Maximum supply voltage	V	230
Power supply frequency	Hz	50
Rated power	W	940
Power of electrical preheater	W	2800
Unit current	A	18.5
Maximum airflow	m ³ /h	830
Sound pressure level LpA at 3 m	dB(A)	52
Heat recovery efficiency, max	%	85
Heat exchanger type	-	Rotary
Heat exchanger material	-	Aluminum
Weight	kg	160
Extract filter	-	G4
Supply filter	-	G4 (опция: F7), G4 (option: F7)
Transported air temperature (max)	°C	40
Transported air temperature (min)	°C	-25
Ambient air temperature min	°C	1
Ambient air temperature max	°C	40

Ambient air humidity max	%	80
Ingress protection rating	-	IP22
Ingress protection rating of the drive	-	IP44

Dimensions

ØD	B	H	L
249	748	750	1667

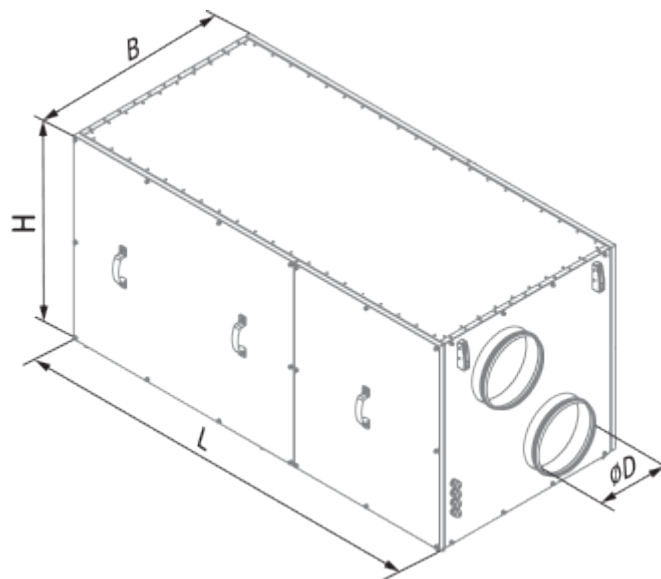



Accessories

Other accessories

Name	Photo	Description
FP 700x352x48 G4		G4 panel filter
FPT 700x351x27 G4		
FPT 700x351x27 F7		

For round ducts

Name	Photo	Description
VRV 250		Backdraft dampers with spring for round ducts

VKA 250		Air dampers for round ducts
-------------------------	---	-----------------------------

Humidity sensors

Name	Photo	Description
FS2		Humidity sensor