



KOMFORT Roto EC LE 1500-9 S18

Air handling units with rotary heat exchanger

- Power of electrical reheater: 9000
- Sound pressure level LpA at 3 m: 62
- Heat exchanger type: Rotary
- Heat exchanger material: Aluminum
- Extract filter: G4
- Supply filter: G4
- Sound-insulated casing
- Reheater: Electric
- Control: Wired control panel
- Casing material: Aluzinc steel
- CO2 sensor: Optional
- PM2.5 sensor: Optional

	Unit of measurement	KOMFORT Roto EC LE 1500-9 S18
Connected air duct size	mm	315
Phases	-	3
Minimum supply voltage	V	400
Maximum supply voltage	V	400
Power supply frequency	Hz	50/60
Rated power	W	750
Power of electrical reheater	W	9000
Unit current	A	14.1
Maximum airflow	m ³ /h	1500
Rotation speed at 50hz	-	2000
Sound pressure level LpA at 3 m	dB(A)	62
Heat recovery efficiency, max	%	95
Heat exchanger type	-	Rotary
Heat exchanger material	-	Aluminum
Weight	kg	175
Extract filter	-	G4
Supply filter	-	G4
Transported air temperature (max)	°C	40
Transported air temperature (min)	°C	-25
Ambient air temperature min	°C	1
Ambient air temperature max	°C	40

Ambient air humidity max	%	80
Ingress protection rating	-	IP22
Ingress protection rating of the drive	-	IP44
Article	-	8046445

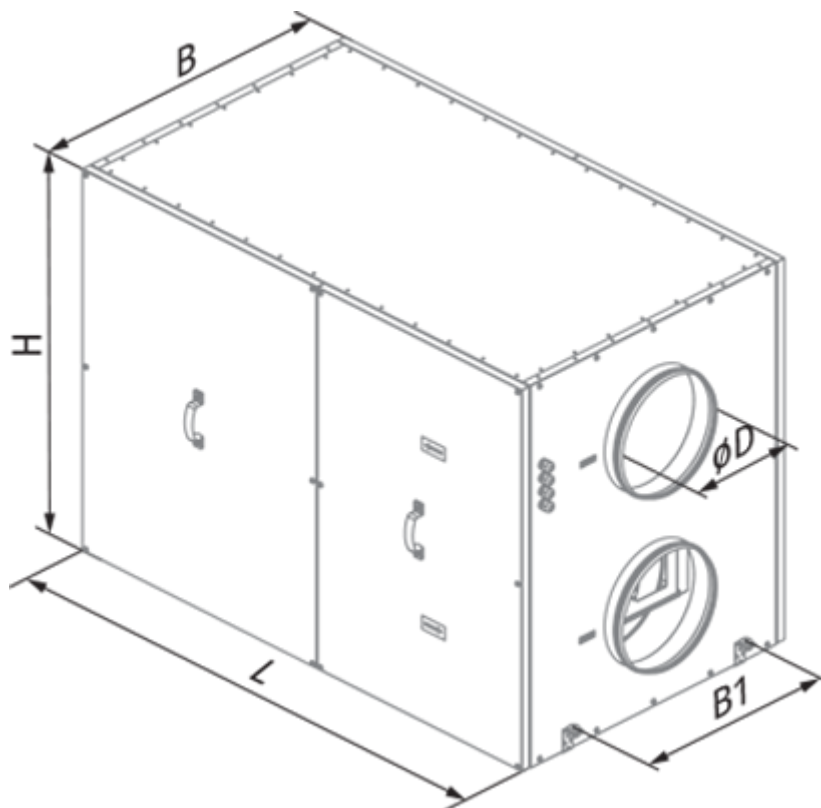

Dimensions

ØD	B	B1	H	L
314	855	560	1010	1430





Accessories

For round ducts

Name	Photo	Description
SD 315/600		Silencers for round ducts
SD 315/900		Silencers for round ducts

SD 315/1200		Silencers for round ducts
-----------------------------	---	---------------------------

For round ducts

Name	Photo	Description
VRV 315		Backdraft dampers with spring for round ducts
VRVS 315		Backdraft air dampers for round ducts

Humidity sensors

Name	Photo	Description
FS2		Humidity sensor

Other accessories

Name	Photo	Description
FP 800x477x47 G4		G4 panel filter