



KOMFORT Roto EC LE 1500-9 S17

Air handling units with rotary heat exchanger

- Power of electrical reheater: 9000
- Maximum airflow: 1500
- Sound pressure level LpA at 3 m: 62
- Heat exchanger type: Rotary
- Extract filter: G4
- Supply filter: G4
- Sound insulation
- Motor type: EC
- Reheater: Electric
- Control: Wired control panel
- Casing material: Aluzinc steel
- Humidity sensor: Optional
- CO2 sensor: Optional
- VOC sensor: Optional
- PM2.5 sensor: Optional

	Unit of measurement	KOMFORT Roto EC LE 1500-9 S17
Connected air duct size	mm	315
Speed	-	1
Phases	-	3
Minimum supply voltage	V	400
Maximum supply voltage	V	400
Power supply frequency	Hz	50/60
Rated power	W	750
Power of electrical reheater	W	9000
Unit current	A	14.1
Maximum airflow	m ³ /h	1500
Sound pressure level LpA at 3 m	dB(A)	62
Heat recovery efficiency, max	%	95
Heat exchanger type	-	Rotary
Heat exchanger material	-	Aluminum
Weight	kg	175
Extract filter	-	G4
Supply filter	-	G4
Transported air temperature (max)	°C	40
Transported air temperature (min)	°C	-25
Ambient air temperature min	°C	1
Ambient air temperature max	°C	40

Ambient air humidity max	%	80
Ingress protection rating	-	IP22
Ingress protection rating of the drive	-	IP44

Dimensions

ØD	B	B1	H	L
314	855	560	1010	1430

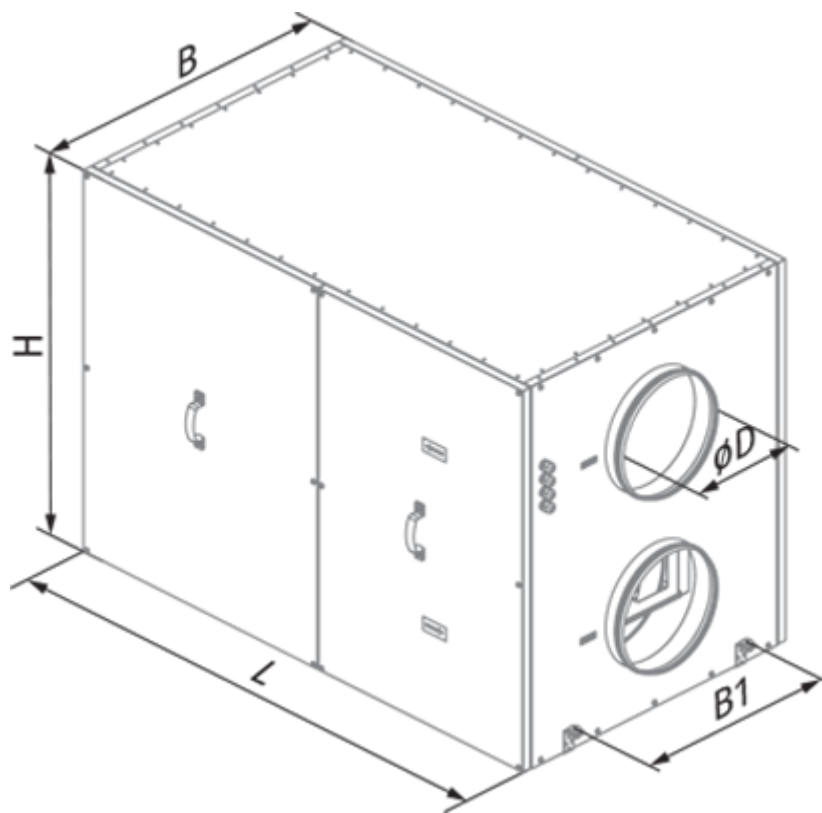



Accessories



Other accessories

Name	Photo	Description
FP 800x477x47 G4		G4 panel filter
FPT 800x477x27 G4		

For round ducts

Name	Photo	Description
SD 315/600		Silencers for round ducts
SD 315/900		Silencers for round ducts
SD 315/1200		Silencers for round ducts

For round ducts

Name	Photo	Description
VRV 315		Backdraft dampers with spring for round ducts
VRVS 315		Backdraft air dampers for round ducts

Humidity sensors

Name	Photo	Description
FS2		Humidity sensor