

KOMFORT Roto EC LE 1000-4.5 S18

Air handling units with rotary heat exchanger

- Power of electrical reheater: 4500
- Maximum airflow: 900
- Sound pressure level LpA at 3 m: 58
- Heat exchanger type: Rotary
- Extract filter: G4
- Supply filter: G4
- Sound insulation
- Motor type: EC
- Reheater: Electric
- Control: Wired control panel
- Casing material: Aluzinc steel
- Humidity sensor: Optional
- CO2 sensor: Optional
- VOC sensor: Optional
- PM2.5 sensor: Optional

	Unit of measurement	KOMFORT Roto EC LE 1000-4.5 S18
Connected air duct size	mm	250
Speed	-	1
Phases	-	3
Minimum supply voltage	V	400
Maximum supply voltage	V	400
Power supply frequency	Hz	50/60
Rated power	W	440
Power of electrical reheater	W	4500
Unit current	A	7.2
Maximum airflow	m ³ /h	900
Sound pressure level LpA at 3 m	dB(A)	58
Heat recovery efficiency, max	%	95
Heat exchanger type	-	Rotary
Heat exchanger material	-	Aluminum
Weight	kg	130
Extract filter	-	G4
Supply filter	-	G4
Transported air temperature (max)	°C	40
Transported air temperature (min)	°C	-25

Ambient air temperature min	°C	1
Ambient air temperature max	°C	40
Ambient air humidity max	%	80
Ingress protection rating	-	IP22
Ingress protection rating of the drive	-	IP44

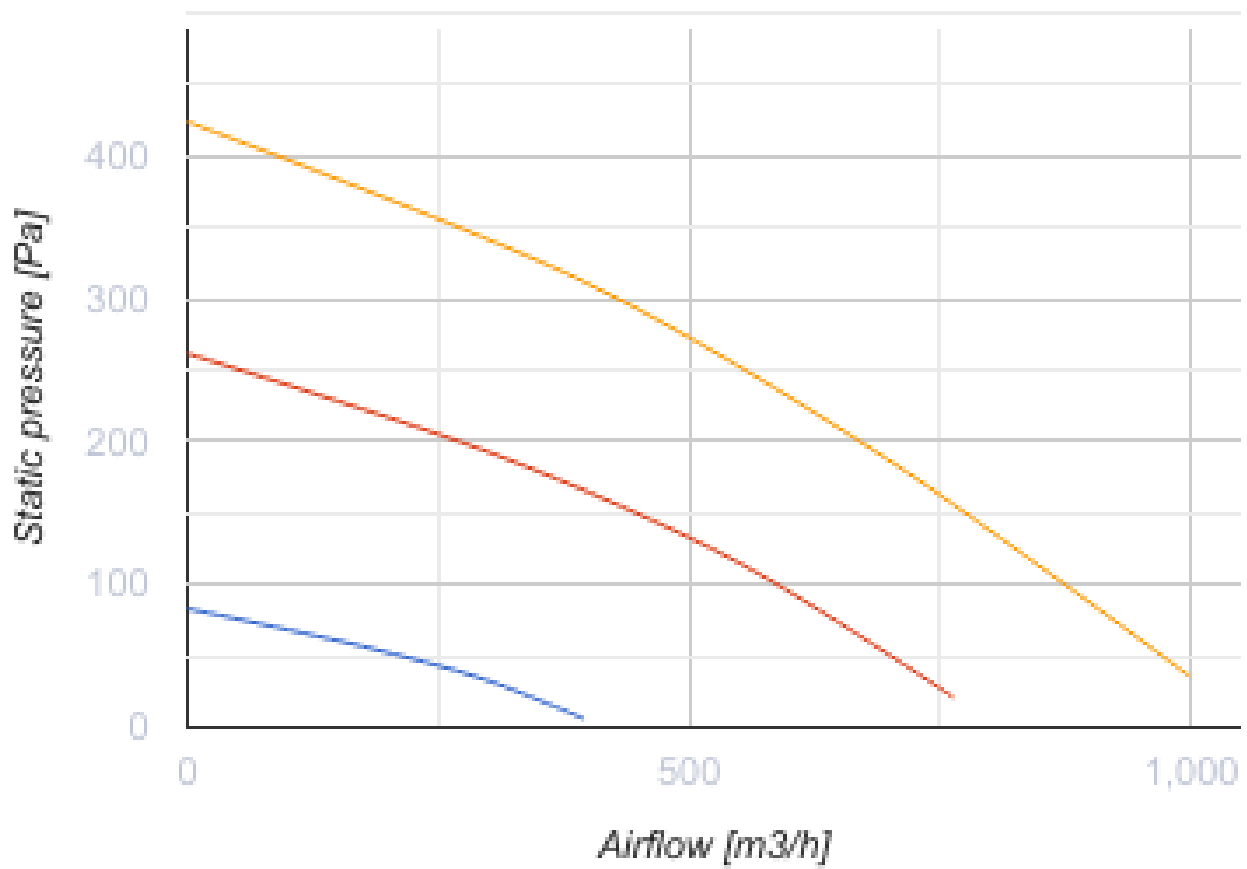

Dimensions

ØD	B	B1	H	L
249	745	580	700	1210

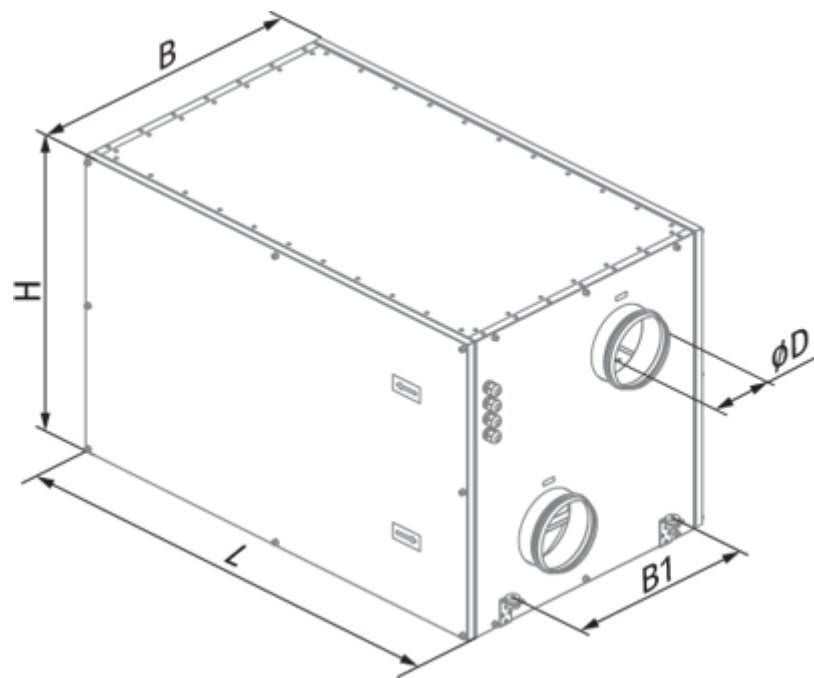



Accessories

Other accessories



Name	Photo	Description
FP 700x332x48 G4		G4 panel filter
FPT 700x333x27 G4		

For round ducts

Name	Photo	Description
SD 250/600		Silencers for round ducts
SD 250/900		Silencers for round ducts
SD 250/1200		Silencers for round ducts

For round ducts

Name	Photo	Description
------	-------	-------------

VRV 250		Backdraft dampers with spring for round ducts
VRVS 250		Backdraft air dampers for round ducts

Humidity sensors

Name	Photo	Description
FS2		Humidity sensor