

KOMFORT Roto EC DE 650 L S21

Suspended heat recovery air handling units



- Power of electrical reheater: 2800
- Maximum airflow: 710
- Sound pressure level LpA at 3 m: 36
- Heat exchanger type: Rotary
- Extract filter: G4
- Supply filter: G4, F7 (option: H13), G4, F7 (опция: H13)
- Sound insulation
- Motor type: EC
- Reheater: Electric
- BMS protocol: ModBus
- Control: Smartphone
- Casing material: Galvanized steel
- Humidity sensor: Optional
- CO2 sensor: Optional
- VOC sensor: Optional
- PM2.5 sensor: Optional

	Unit of measurement	KOMFORT Roto EC DE 650 L S21
Connected air duct size	mm	200
Speed	-	1
Phases	-	1
Minimum supply voltage	V	230
Maximum supply voltage	V	230
Power supply frequency	Hz	50/60
Rated power	W	367
Power of electrical reheater	W	2800
Unit current	A	13.7
Maximum airflow	m ³ /h	710
Sound pressure level LpA at 3 m	dB(A)	36
Heat recovery efficiency, max	%	87
Heat exchanger type	-	Rotary
Heat exchanger material	-	Aluminum
Weight	kg	104
Extract filter	-	G4
Supply filter	-	G4, F7 (option: H13), G4, F7 (опция: H13)
Transported air temperature (max)	°C	40
Transported air temperature (min)	°C	-25

Ambient air temperature min	°C	1
Ambient air temperature max	°C	40
Ambient air humidity max	%	80
Ingress protection rating	-	IP22
Ingress protection rating of the drive	-	IP44

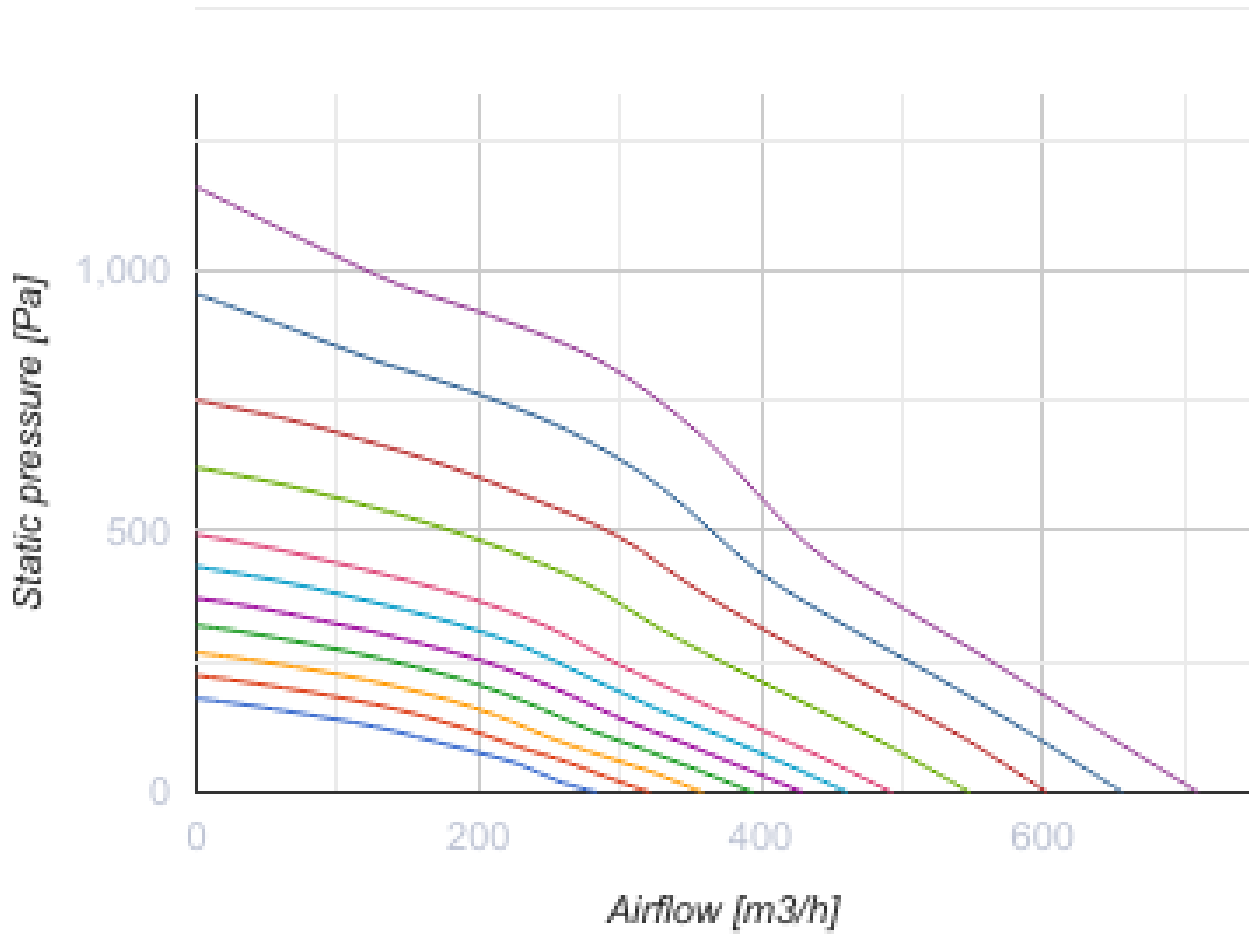

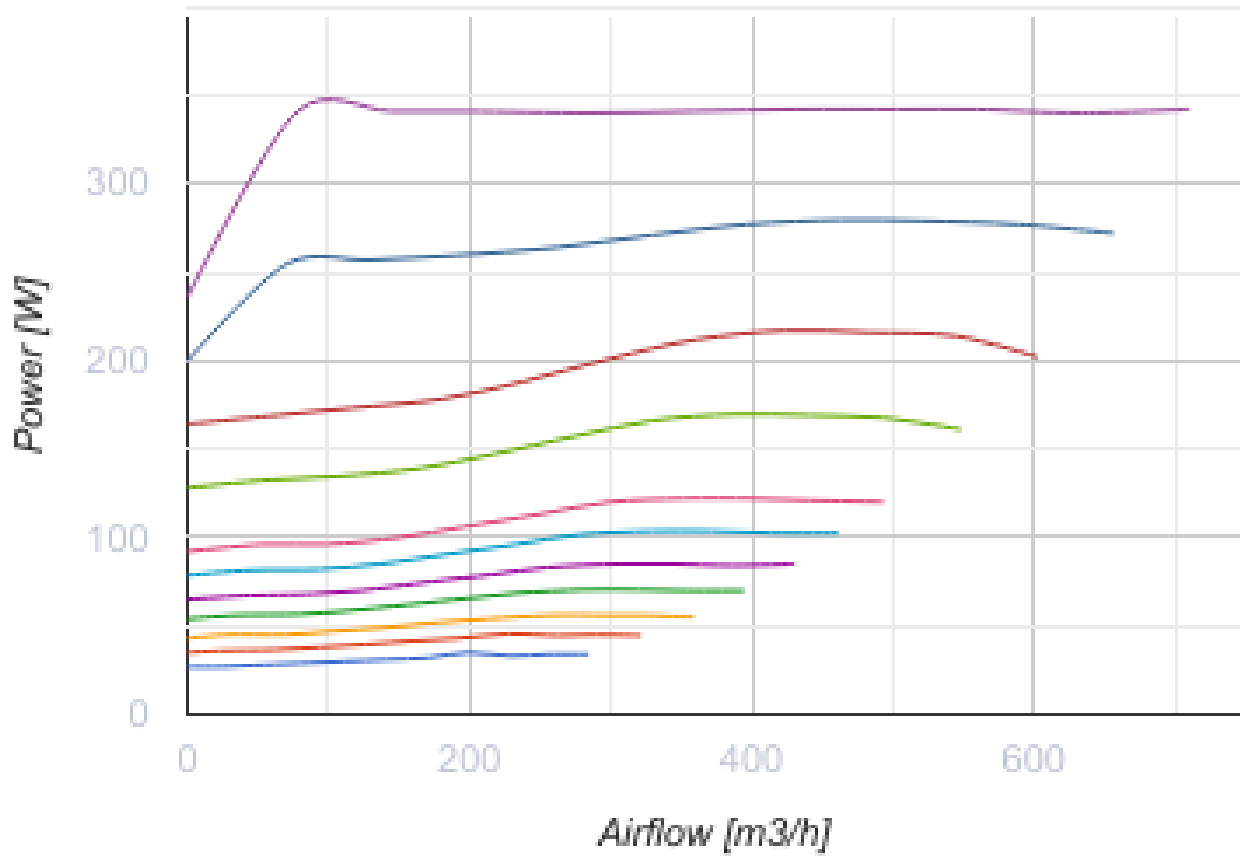

Dimensions

Ø D	Ø D1	B	B1	H	H1	L	L1
200	125	897	932	409	422	1445	1542

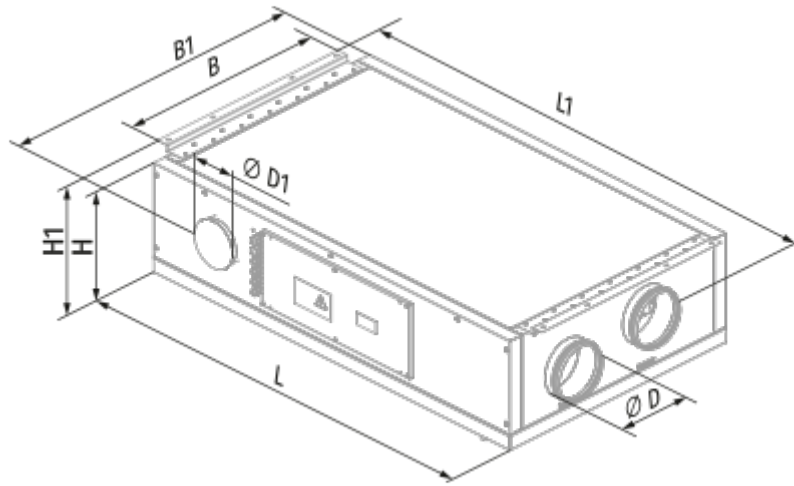

Ecodesign

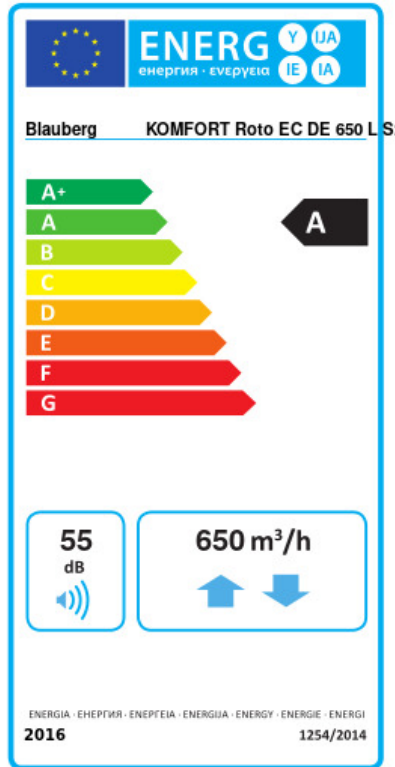

Trademark	Blauberg		
Model	KOMFORT Roto EC DE 650 L S21		
Specific energy consumption (SEC) (kWh/(m ² /a))	Cold	Average	Warm
	85.4	A+	17
Type of ventilation unit	Bidirectional		
Type of drive installed	Variable speed		
Type of heat recovery system	Regenerative		
Thermal efficiency of heat recovery (%)	83		
Maximum flow rate (m ³ /h)	650		
Electric power input (W)	340		
Reference flow rate (m ³ /s)	0.125		
Reference pressure difference (Pa)	50		
Specific power input (SPI) (W/(m ³ /h))	0.269		
Control typology	Local demand control		
Maximum internal leakage rates (%)	2.7		
Maximum external leakage rates (%)	2.7		
Sound power level (dB(A))	55		
Declared typology	RVU BVU		
The annual electricity consumption (AEC) (kWh/a)	Cold	Average	Warm
	142	142	142
The annual heating saved (AHS) (kWh/a)	Cold	Average	Warm
	8898	4548	2057



Accessories

Other accessories

Name	Photo	Description
FP 378x295x48 G4		G4 panel filter

FP 378x295x48 F7		F7 panel filter
FP 378x295x48 H13		

Control Panels

Name	Photo	Description
S22		Control panels
S22 Wi-Fi		Control panels
S25		LCD control panel

Humidity sensors

Name	Photo	Description
FS2		Humidity sensor

Other accessories

Name	Photo	Description
DAH 251-13		Kitchen exhaust hood

For round ducts

Name	Photo	Description
VRV 200		Backdraft dampers with spring for round ducts
VKA 200		Air dampers for round ducts