

# KOMFORT Roto EC DE 250 L S21

Suspended heat recovery air handling units



- Power of electrical reheater: 700
- Maximum airflow: 310
- Sound pressure level LpA at 3 m: 21
- Heat exchanger type: Rotary
- Extract filter: G4
- Supply filter: G4, F7 (option: H13)
- Sound insulation
- Motor type: EC
- Reheater: Electric
- BMS protocol: ModBus
- Control: Smartphone
- Casing material: Galvanized steel
- Humidity sensor: Optional
- CO2 sensor: Optional
- VOC sensor: Optional
- PM2.5 sensor: Optional

	Unit of measurement	KOMFORT Roto EC DE 250 L S21
Connected air duct size	mm	160
Speed	-	1
Phases	-	1
Minimum supply voltage	V	230
Maximum supply voltage	V	230
Power supply frequency	Hz	50/60
Rated power	W	135
Power of electrical reheater	W	700
Unit current	A	4.1
Maximum airflow	m <sup>3</sup> /h	310
Sound pressure level LpA at 3 m	dB(A)	21
Heat recovery efficiency, max	%	87
Heat exchanger type	-	Rotary
Heat exchanger material	-	Aluminum
Weight	kg	56
Extract filter	-	G4
Supply filter	-	G4, F7 (option: H13)
Transported air temperature (max)	°C	40
Transported air temperature (min)	°C	-25
Ambient air temperature min	°C	1

Ambient air temperature max	°C	40
Ambient air humidity max	%	80
Ingress protection rating	-	IP22
Ingress protection rating of the drive	-	IP44

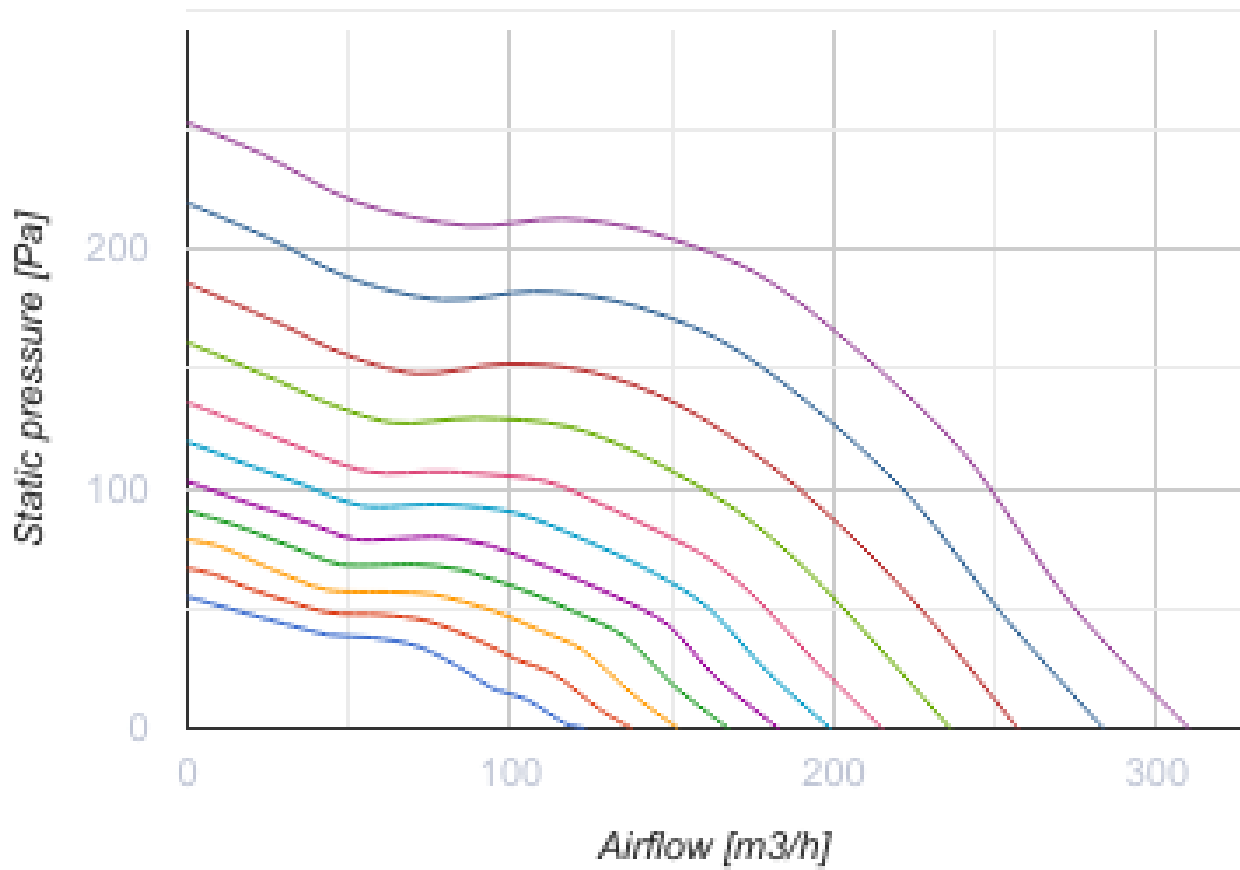

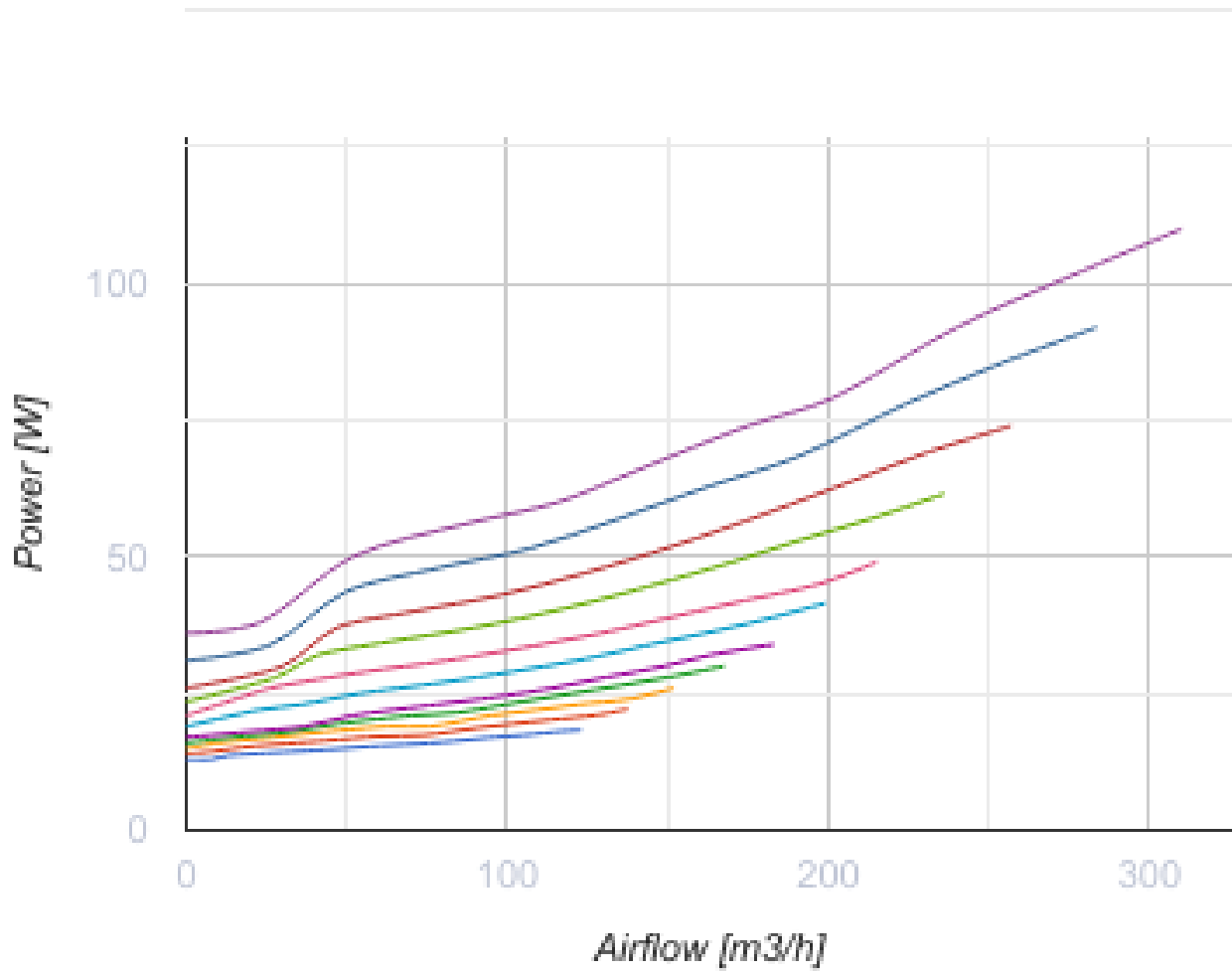

## Dimensions

Ø D	Ø D1	B	B1	H	H1	L	L1
160	125	643	688	308	345	1003	1100

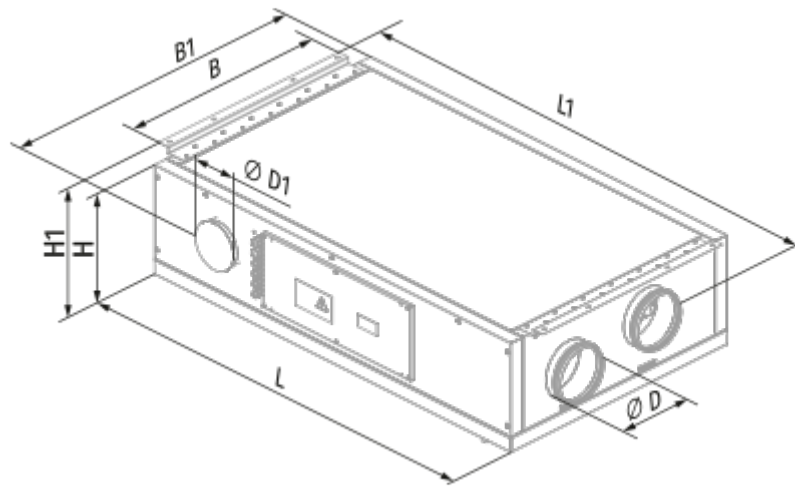

## Ecodesign

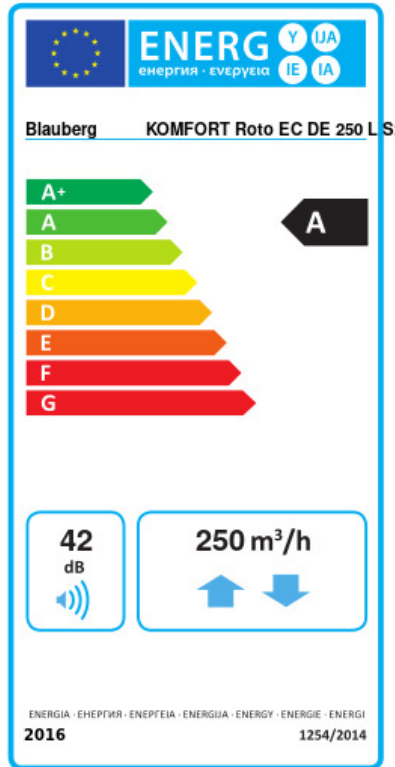

Trademark	Blauberg					
Model	KOMFORT Roto EC DE 250 L S21					
Specific energy consumption (SEC) (kWh/(m <sup>2</sup> /a))	Cold		Average		Warm	
	84.2	A+	41.5	A	17	E
Type of ventilation unit	Bidirectional					
Type of drive installed	Variable speed					
Type of heat recovery system	Regenerative					
Thermal efficiency of heat recovery (%)	79					
Maximum flow rate (m <sup>3</sup> /h)	250					
Electric power input (W)	95					
Reference flow rate (m <sup>3</sup> /s)	0.049					
Reference pressure difference (Pa)	50					
Specific power input (SPI) (W/(m <sup>3</sup> /h))	0.24					
Control typology	Local demand control					
Maximum internal leakage rates (%)	2.7					
Maximum external leakage rates (%)	2.7					
Sound power level (dB(A))	42					
Declared typology	RVU BVU					
The annual electricity consumption (AEC) (kWh/a)	Cold		Average		Warm	
	127		127		127	
The annual heating saved (AHS) (kWh/a)	Cold		Average		Warm	
	8736		4466		2019	



## Accessories

### Other accessories

Name	Photo	Description
FP 260x220x48 G4		G4 panel filter

FP 260x220x48 F7		F7 panel filter
FP 260x220x48 H13		

### Other accessories

Name	Photo	Description
<a href="#">S22</a>		Control panels
<a href="#">S22 Wi-Fi</a>		Control panels
<a href="#">S25</a>		LCD control panel

### Other accessories

Name	Photo	Description
<a href="#">FS2</a>		Humidity sensor

### Other accessories

Name	Photo	Description
<a href="#">DAH 251-13</a>		Kitchen exhaust hood

### Other accessories

Name	Photo	Description
<a href="#">VRV 160</a>		Backdraft dampers with spring for round ducts
<a href="#">VKA 160</a>		Air dampers for round ducts