



KOMFORT LE 1700-18

Heat recovery air handling units

- Power of electrical reheater: 18000
- Maximum airflow: 1750
- Sound pressure level LpA at 3 m: 49
- Heat exchanger type: Cross flow
- Extract filter: G4
- Supply filter: G4
- Sound insulation
- Motor type: AC
- Reheater: Electric
- Control: Wired control panel
- Casing material: Galvanized steel

	Unit of measurement	KOMFORT LE 1700-18
Connected air duct size	mm	315
Speed	-	1
Phases	-	3
Minimum supply voltage	V	230
Maximum supply voltage	V	230
Power supply frequency	Hz	50/60
Rated power	W	980
Power of electrical reheater	W	18000
Unit current	A	30.3
Maximum airflow	m ³ /h	1750
Sound pressure level LpA at 3 m	dB(A)	49
Heat recovery efficiency, max	%	77
Heat exchanger type	-	Cross flow
Heat exchanger material	-	Polystyrene
Weight	kg	96
Extract filter	-	G4
Supply filter	-	G4
Transported air temperature (max)	°C	40
Transported air temperature (min)	°C	-25
Ambient air temperature min	°C	1
Ambient air temperature max	°C	40

Ambient air humidity max	%	80
Ingress protection rating	-	IP22
Ingress protection rating of the drive	-	IP44

Dimensions

ØD	B	B1	H	H1	L	L1	L2
314	842	581	814	947	1345	1394	1447

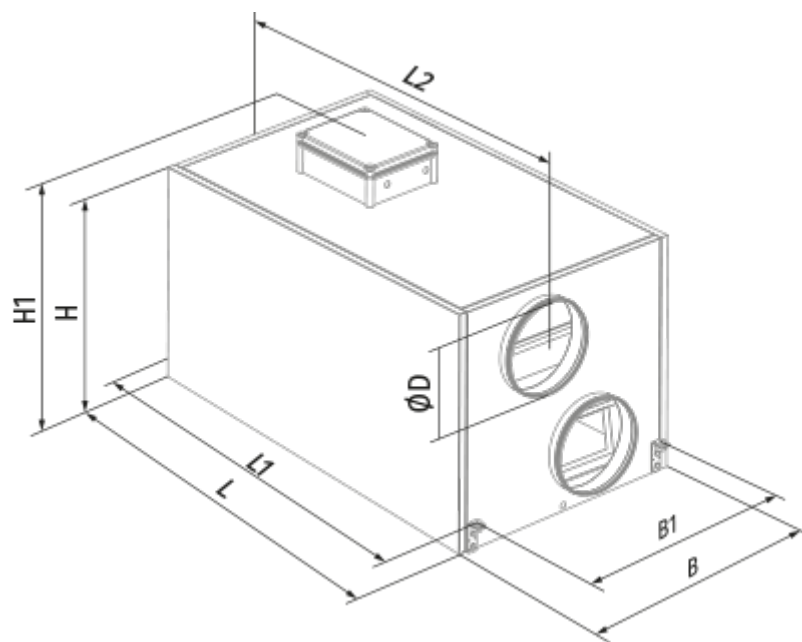

Accessories

Other accessories

Name	Photo	Description
FP 780x273x48 G4		G4 panel filter
SB C4 300/300		

For round ducts

Name	Photo	Description
------	-------	-------------

SD 315/600		Silencers for round ducts
SD 315/900		Silencers for round ducts
SD 315/1200		Silencers for round ducts
SDF 315/600		Flexible silencers for round ducts
SDF 315/900		Flexible silencers for round ducts
SDF 315/2000		Flexible silencers for round ducts

For round ducts

Name	Photo	Description
VRV 315		Backdraft dampers with spring for round ducts