



KOMFORT L 500

Heat recovery air handling units

- Maximum airflow: 500
- Sound pressure level LpA at 3 m: 28-47
- Heat exchanger type: Cross flow
- Extract filter: G4
- Supply filter: G4
- Sound insulation
- Motor type: AC
- Control: Speed switch
- Casing material: Aluzinc steel

	Unit of measurement	KOMFORT L 500
Connected air duct size	mm	150
Speed	-	1
Phases	-	1
Minimum supply voltage	V	230
Maximum supply voltage	V	230
Power supply frequency	Hz	50/60
Rated power	W	300
Unit current	A	1.32
Maximum airflow	m ³ /h	500
Sound pressure level LpA at 3 m	dB(A)	28-47
Heat recovery efficiency, max	%	88
Heat exchanger type	-	Cross flow
Heat exchanger material	-	Polystyrene
Weight	kg	49
Extract filter	-	G4
Supply filter	-	G4
Transported air temperature (max)	°C	40
Transported air temperature (min)	°C	-25
Ambient air temperature min	°C	1
Ambient air temperature max	°C	50
Ambient air humidity max	%	80

Ingress protection rating	-	IP22
Ingress protection rating of the drive	-	IP44

Dimensions

ØD	B	H	L	L1
149	416	603	722	768

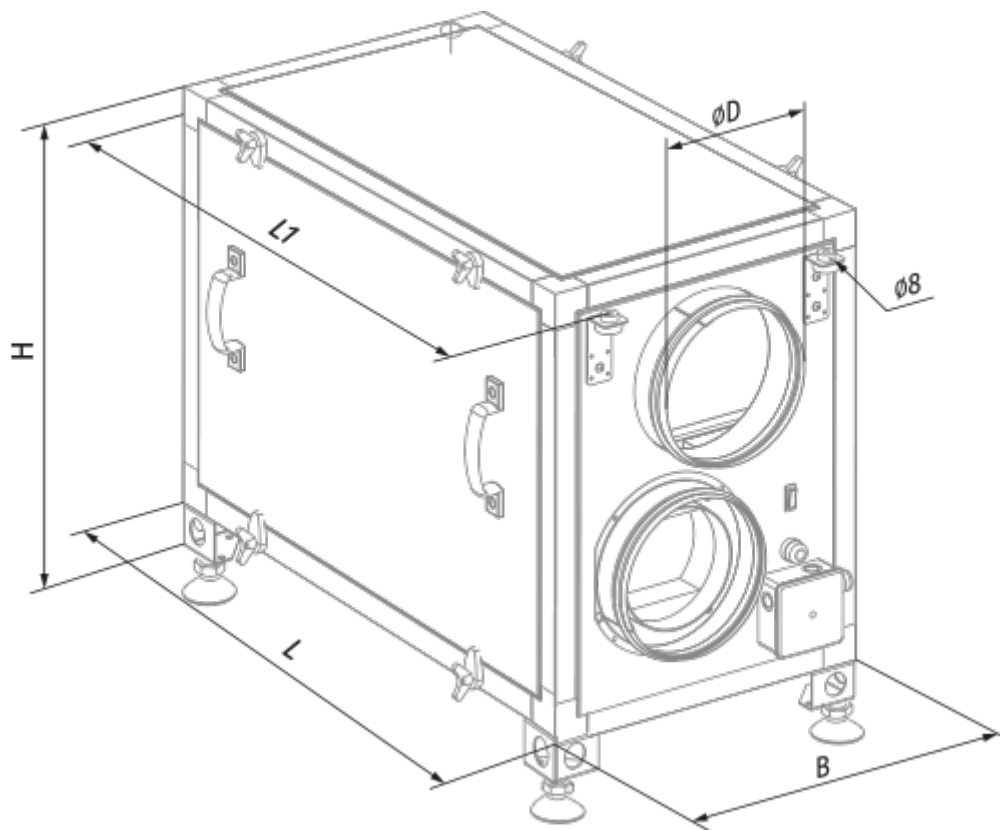

Ecodesign

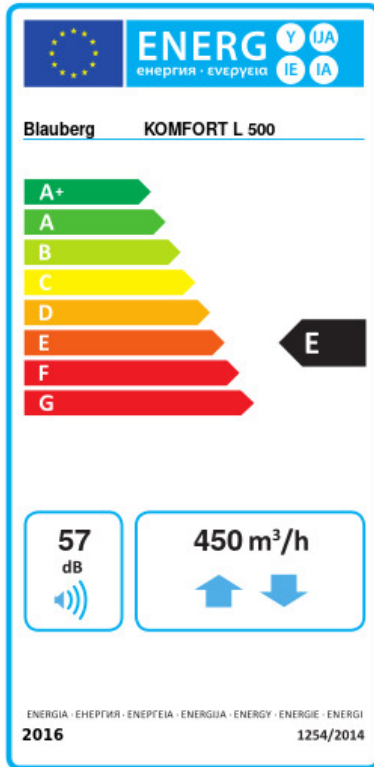



Trademark	Blauberg			
Model	KOMFORT L 500			
Specific energy consumption (SEC) (kWh/(m ² /a))	Cold	Average	Warm	
	47.3	A+	17.1	E 2.9 G
Type of ventilation unit	Bidirectional			
Type of drive installed	Multi-speed			
Type of heat recovery system	Recuperative			
Thermal efficiency of heat recovery (%)	63			
Maximum flow rate (m ³ /h)	450			
Electric power input (W)	300			
Reference flow rate (m ³ /s)	0.088			
Reference pressure difference (Pa)	50			
Specific power input (SPI) (W/(m ³ /h))	0.603			
Control typology	Manual control			
Maximum internal leakage rates (%)	2.7			
Maximum external leakage rates (%)	2.7			
Sound power level (dB(A))	57			
Declared typology	RVU BVU			
The annual electricity consumption (AEC) (kWh/a)	Cold	Average	Warm	
	1369	832	787	
The annual heating saved (AHS) (kWh/a)	Cold	Average	Warm	
	7281	3722	1683	

Accessories

Other accessories

Name	Photo	Description
FP 436x215x48 G4		G4 panel filter
SB C4 300/384		

For round ducts

Name	Photo	Description
SD 150/600		Silencers for round ducts
SD 150/900		Silencers for round ducts
SD 150/1200		Silencers for round ducts

For round ducts

Name	Photo	Description
VRV 150		Backdraft dampers with spring for round ducts