

# KOMFORT ERV EC DB 350 R S14

Suspended heat and energy recovery air handling units



- Maximum airflow: 430
- Sound pressure level LpA at 3 m: 46
- Heat exchanger type: Cross flow
- Extract filter: G4
- Supply filter: G4 + F8 (PM2.5 > 87 %)
- Sound insulation
- Motor type: EC
- Enthalpy heat exchanger
- Bypass: Manual
- Control: Wired control panel
- Casing material: Coated steel
- Humidity sensor: Optional
- CO2 sensor: Optional

	Unit of measurement	KOMFORT ERV EC DB 350 R S14
Connected air duct size	mm	150
Speed	-	1
Phases	-	1
Minimum supply voltage	V	230
Maximum supply voltage	V	230
Power supply frequency	Hz	50/60
Rated power	W	171
Unit current	A	1.3
Maximum airflow	m <sup>3</sup> /h	430
Sound pressure level LpA at 3 m	dB(A)	46
Heat recovery efficiency, max	%	85
Heat exchanger type	-	Cross flow
Heat exchanger material	-	Enthalpy
Weight	kg	42
Extract filter	-	G4
Supply filter	-	G4 + F8 (PM2.5 > 87 %)
Transported air temperature (max)	°C	40
Transported air temperature (min)	°C	-5
Ambient air temperature min	°C	1
Ambient air temperature max	°C	40
Ambient air humidity max	%	60

Ingress protection rating	-	IP22
Ingress protection rating of the drive	-	IP44

## Dimensions

D	B	H	L	L1
150	754	277	1024	1157

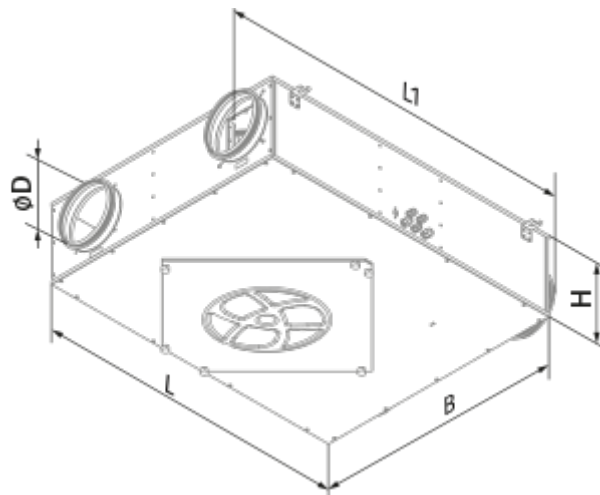

## Ecodesign

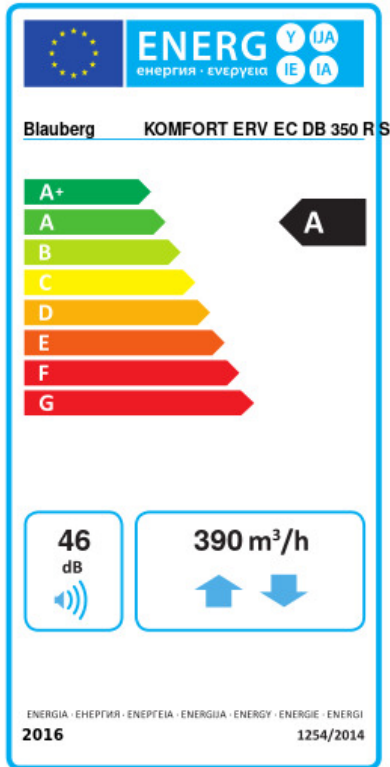

Trademark	Blauberg					
Model	KOMFORT ERV EC DB 350 R S14					
Specific energy consumption (SEC) (kWh/(m²/a))	Cold		Average		Warm	
	74.6241	A+	38.8747	A	15.7687	E
Type of ventilation unit	Bidirectional					
Type of drive installed	Variable speed					
Type of heat recovery system	Recuperative					
Thermal efficiency of heat recovery (%)	71					
Maximum flow rate (m³/h)	390					
Electric power input (W)	170					
Reference flow rate (m³/s)	0.075					
Reference pressure difference (Pa)	50					
Specific power input (SPI) (W/(m³/h))	0.278					
Control typology	Local demand control					
Maximum internal leakage rates (%)	2.7					
Maximum external leakage rates (%)	2.7					
Sound power level (dB(A))	46					
Declared typology	RVU BVU					
The annual electricity consumption (AEC) (kWh/a)	Cold		Average		Warm	
	729.0159		192.0159		147.0159	
The annual heating saved (AHS) (kWh/a)	Cold		Average		Warm	
	8411.7362		4299.8985		1944.3574	

## Accessories



### Other accessories

Name	Photo	Description
FP 300x270x48 G4		G4 panel filter
FP 300x270x48 F8		

### Humidity sensors

Name	Photo	Description
<a href="#">FS2</a>		Humidity sensor

### CO2 sensors

Name	Photo	Description
<a href="#">CD-1</a>		CO2 sensors
<a href="#">CD-2</a>		CO2 sensors

### For round ducts

Name	Photo	Description
<a href="#">VKA 150</a>		Air dampers for round ducts