

# KOMFORT ERV D 450 R S3

Suspended heat and energy recovery air handling units



- Maximum airflow: 500
- Sound pressure level LpA at 3 m: 57
- Heat exchanger type: Cross flow
- Extract filter: G4
- Supply filter: G4 and F8 (PM2.5 > 93 %), G4 and F8 (PM2.5 > 93 %)
- Sound insulation
- Motor type: AC
- Enthalpy heat exchanger
- Control: Speed switch
- Casing material: Coated steel

|                                   | Unit of measurement | KOMFORT ERV D 450 R S3                             |
|-----------------------------------|---------------------|--|
| Connected air duct size           | mm                  | 150  |
| Speed                             | -                   | 1  |
| Phases                            | -                   | 1  |
| Minimum supply voltage            | V                   | 230  |
| Maximum supply voltage            | V                   | 230  |
| Power supply frequency            | Hz                  | 50   |
| Rated power                       | W                   | 354  |
| Unit current                      | A                   | 1.54   |
| Maximum airflow                   | m <sup>3</sup> /h   | 500  |
| Sound pressure level LpA at 3 m   | dB(A)               | 57   |
| Heat recovery efficiency, max     | %                   | 87   |
| Heat exchanger type               | -                   | Cross flow   |
| Heat exchanger material           | -                   | Enthalpy   |
| Weight                            | kg                  | 39   |
| Extract filter                    | -                   | G4   |
| Supply filter                     | -                   | G4 and F8 (PM2.5 > 93 %), G4 and F8 (PM2.5 > 93 %) |
| Transported air temperature (max) | °C                  | 40   |
| Transported air temperature (min) | °C                  | -5   |
| Ambient air temperature min       | °C                  | 1  |
| Ambient air temperature max       | °C                  | 40   |
| Ambient air humidity max          | %                   | 60   |

|  |   |      |
|--|---|------|
| Ingress protection rating              | - | IP22 |
| Ingress protection rating of the drive | - | IP44 |

## Dimensions

| D   | B   | H   | L    |
|-----|-----|-----|------|
| 150 | 704 | 227 | 1020 |

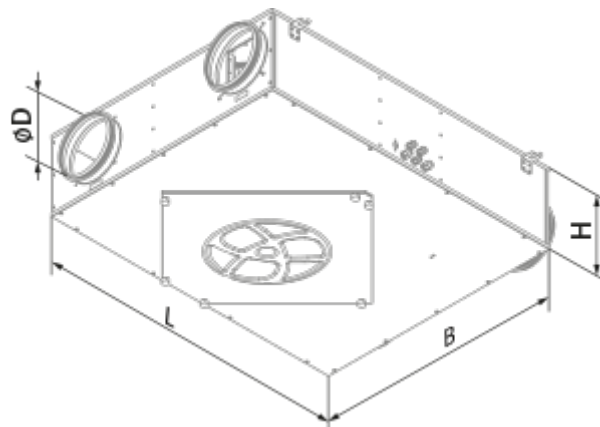

## Ecodesign

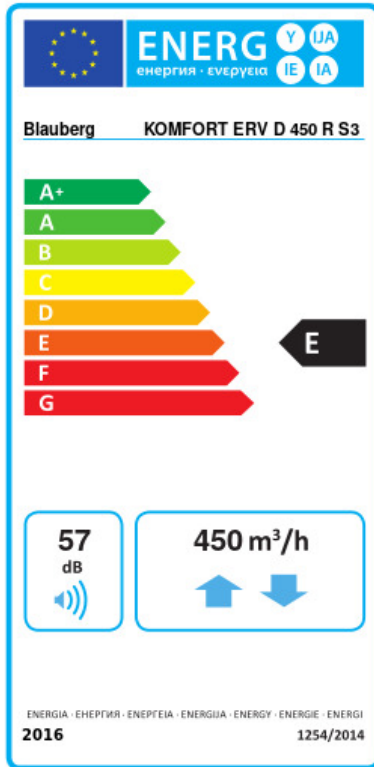

|   |                        |         |      |         |
|---|------------------------|---------|------|---------|
| Trademark   | Blauberg               |         |      |         |
| Model   | KOMFORT ERV D 450 R S3 |         |      |         |
| Specific energy consumption (SEC) (kWh/(m <sup>2</sup> /a)) | Cold                   | Average | Warm |         |
|   | 47.9                   | A+      | 14.6 | E 7.1 G |
| Type of ventilation unit                                    | Bidirectional          |         |      |         |
| Type of drive installed                                     | Variable speed         |         |      |         |
| Type of heat recovery system                                | Recuperative           |         |      |         |
| Thermal efficiency of heat recovery (%)                     | 73                     |         |      |         |
| Maximum flow rate (m <sup>3</sup> /h)                       | 450                    |         |      |         |
| Electric power input (W)                                    | 340                    |         |      |         |
| Reference flow rate (m <sup>3</sup> /s)                     | 0.094                  |         |      |         |
| Reference pressure difference (Pa)                          | 50                     |         |      |         |
| Specific power input (SPI) (W/(m <sup>3</sup> /h))          | 0.809                  |         |      |         |
| Control typology  | Manual control         |         |      |         |
| Maximum internal leakage rates (%)                          | 2.7                    |         |      |         |
| Maximum external leakage rates (%)                          | 2.7                    |         |      |         |
| Sound power level (dB(A))                                   | 57                     |         |      |         |
| Declared typology   | RVU BVU                |         |      |         |
| The annual electricity consumption (AEC) (kWh/a)            | Cold                   | Average | Warm |         |
|   | 1595                   | 1058    | 1013 |         |
| The annual heating saved (AHS) (kWh/a)                      | Cold                   | Average | Warm |         |
|   | 7904                   | 4040    | 1827 |         |

## Accessories

### Other accessories

| Name             | Photo | Description     |
|------------------|-------|-----------------|
| FP 300x270x48 G4 |       | G4 panel filter |
| FP 300x270x48 F8 |       |                 |

SB C4 300/270