

KOMFORT ERV D 200 L S4

Suspended heat and energy recovery air handling units



- Maximum airflow: 280
- Sound pressure level LpA at 3 m: 49
- Heat exchanger type: Cross flow
- Extract filter: G4
- Supply filter: G4 and F8 (PM2.5 > 93 %)
- Sound insulation
- Motor type: AC
- Enthalpy heat exchanger
- Control: Speed switch
- Casing material: Coated steel

	Unit of measurement	KOMFORT ERV D 200 L S4
Connected air duct size	mm	100
Speed	-	1
Phases	-	1
Minimum supply voltage	V	230
Maximum supply voltage	V	230
Power supply frequency	Hz	50
Rated power	W	141
Unit current	A	0.63
Maximum airflow	m ³ /h	280
Sound pressure level LpA at 3 m	dB(A)	49
Heat recovery efficiency, max	%	87
Heat exchanger type	-	Cross flow
Heat exchanger material	-	Enthalpy
Weight	kg	24
Extract filter	-	G4
Supply filter	-	G4 and F8 (PM2.5 > 93 %)
Transported air temperature (max)	°C	40
Transported air temperature (min)	°C	-5
Ambient air temperature min	°C	1
Ambient air temperature max	°C	40
Ambient air humidity max	%	60

Ingress protection rating	-	IP22
Ingress protection rating of the drive	-	IP44

Dimensions

D	B	H	L
100	704	227	854

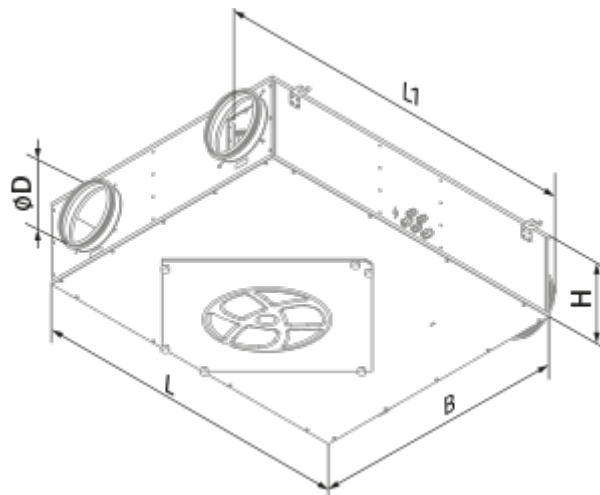

Ecodesign

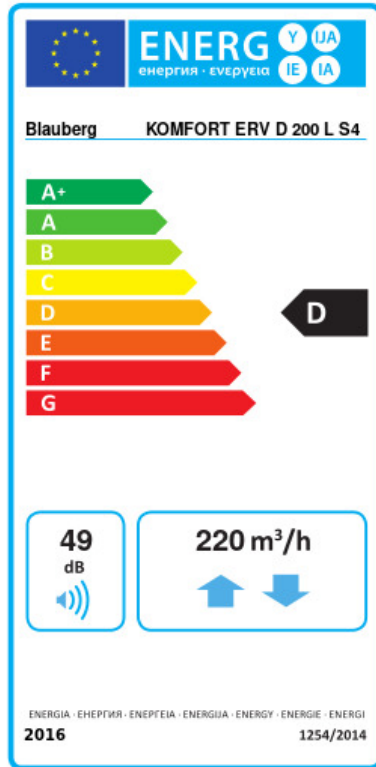

Trademark	Blauberg		
Model	KOMFORT ERV D 200 L S4		
Specific energy consumption (SEC) (kWh/(m ² /a))	Cold	Average	Warm
	56.7	A+ 21.6	D 1.1 G
Type of ventilation unit	Bidirectional		
Type of drive installed	Variable speed		
Type of heat recovery system	Recuperative		
Thermal efficiency of heat recovery (%)	79		
Maximum flow rate (m ³ /h)	220		
Electric power input (W)	132		
Reference flow rate (m ³ /s)	0.054		
Reference pressure difference (Pa)	50		
Specific power input (SPI) (W/(m ³ /h))	0.646		
Control typology	Manual control		
Maximum internal leakage rates (%)	2.7		
Maximum external leakage rates (%)	2.7		
Declared typology	RVU BVU		
Sound power level (dB(A))	49		
The annual electricity consumption (AEC) (kWh/a)	Cold	Average	Warm
	1391	854	809
The annual heating saved (AHS) (kWh/a)	Cold	Average	Warm
	8278	4231	1913

Accessories

Other accessories

Name	Photo	Description
FP 300x220x48 G4		G4 panel filter
FP 300x220x48 F8		

SB C4 300/220